

2001

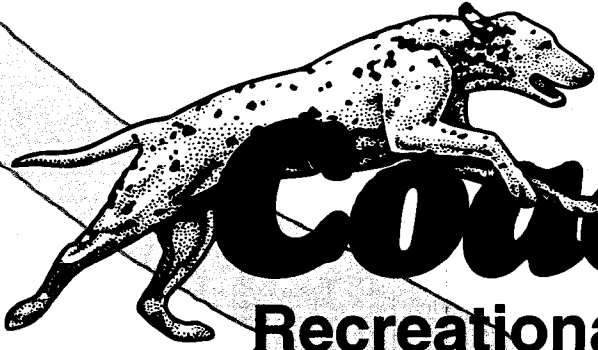

**Couchmen<sup>®</sup>**

**Recreational Vehicle Company**

A large, stylized graphic of a hand holding a steering wheel, rendered in solid black. The hand is positioned on the right side of the page, with the fingers gripping the wheel. The background features a grid of lines.

**Mirada**

**Class A Gas Motorhome  
Owner's Manual**

Welcome to Coachmen's growing family of happy RV owners. Hours of relaxation, adventure and enjoyment await you in your new Coachmen unit. Thousands of Coachmen RV owners have been enjoying their units for many years.

This Owner's Manual has been prepared to help you and your family enjoy your new Coachmen RV to its fullest by providing basic instructions for the operation and maintenance of its appliances, accessories and RV systems. Please read it carefully and follow the instructions. Also read and follow the instructions contained in the chassis, appliance and accessory manufacturers' instruction booklets provided as part of the "Coachmen Information Packet."

If you have any questions regarding operation, maintenance or service, please contact your Coachmen dealer so he can assist you. Your satisfaction is of the utmost importance to your dealer and to Coachmen.

Operation and maintenance instructions regarding appliances in this manual were obtained from the manufacturer's booklets and are used with the permission of those various manufacturers. Coachmen Industries reserves the right to present edited portions of these materials.

Coachmen Industries, Inc. works year round to improve its product. As a result, all specifications, equipment and prices quoted are subject to change without notice or obligation to the consumer.

Coachmen offers a wide variety of recreational vehicle models and choices of standard and optional equipment; therefore, certain descriptions in this manual may not apply to your unit. Ask your authorized dealer, or see the current brochure for information on the availability of standard or optional equipment.

Thank you for selecting our product. The entire Coachmen Industries family strives to merit your confidence.

# Table of Contents

<b>APPENDIX A: PRE-TRAVEL CHECK</b> .....	40	Parking on an Upgrade .....	13
<b>APPENDIX B: TRAVEL PREPARATION CHECKLIST</b> .....	41	Freeing a Stuck Vehicle .....	13
<b>APPENDIX C: TROUBLESHOOTING GUIDE</b> .....	42	Speed Control .....	13
<b>APPLIANCE IDENTIFICATION FORM</b> .....	49	Tire Change .....	13
Electrical Specifications .....	50	<b>FIRE SAFETY</b> .....	37
<b>APPLIANCES &amp; ACCESSORIES</b> .....	29	Smoke Detector .....	37
Range, Range Hood, Oven .....	29	Emergency Exits .....	37
Microwave Oven .....	30	<b>IMPORTANT SAFETY REGULATIONS</b> .....	8
Water Heater .....	31	<b>INTRODUCTION</b> .....	7
Furnace .....	31	Licenses .....	9
Refrigerator .....	32	Insurance .....	9
Roof Air Conditioners .....	33	<b>LIVING AREA</b> .....	19
Washer/Dryer .....	34	Air Quality .....	19
<b>BASIC UTILITY SYSTEMS</b> .....	21	Condensation .....	19
Monitor Panel .....	21	Controlling Condensation .....	19
Electrical System .....	21	<b>LOADING</b> .....	9
Power Distribution Chart .....	21	Weight Determinations .....	9
Generator .....	22	Definitions .....	9
A/C Selector Switches .....	23	Vehicle Weighing .....	11
Fresh Water System .....	24	Towing .....	11
Drainage/Sewer System .....	26	<b>MAINTENANCE RECORD</b> .....	47
LP Gas System .....	27	<b>MAINTENANCE SCHEDULE</b> .....	48
Climate Differences .....	28	<b>OPTIONAL LIVING AREA FEATURES</b> .....	34
Regulator Pressure .....	28	AM/FM Radio and/or Cassette Tape Player .....	34
LP Leak Detector .....	28	TV Antenna/Cable System .....	34
LP Gas Regulator Freeze Ups .....	28	Television .....	35
Filling LP Gas Tanks .....	29	VCR/VCP .....	35
LP Gas Line Check .....	29	Cable TV and Phone Jack .....	35
<b>CAMPING</b> .....	14	Back-Up Camera .....	35
Campsite Selection .....	14	Battery Disconnect .....	35
Set-Up .....	14	Electric Step .....	35
Leveling .....	14	<b>REPORTING SAFETY DEFECTS</b> .....	55
Hydraulic Levelers .....	15	<b>RV MAINTENANCE</b> .....	37
Slide-Out Room Operation .....	16	<b>STORAGE</b> .....	36
<b>DASH INSTRUMENT CONTROLS</b> .....	14	<b>TRAVEL PREPARATIONS</b> .....	7
<b>DRIVING</b> .....	11	General Driving Checks .....	7
Safety Seat Belts .....	12	Important Documents .....	7
Clearance .....	12	Courtesy .....	7
Mirrors .....	12	Tourist Information .....	8
Braking .....	12	<b>TRAVEL RECORD</b> .....	46
Upgrades .....	12	<b>VISITING CANADA OR MEXICO</b> .....	8
Downgrades .....	12	<b>WARRANTY</b> .....	4-5
Passing .....	12	<b>WINTERIZATION</b> .....	36
Swaying or Fishtailing .....	12		
Cross Winds .....	12		
Turning .....	12		
Backing .....	13		
Overheating .....	14		
Parking on a Grade .....	13		

# IMPORTANT SAFETY REGULATIONS

## ... please read carefully.

### LP GAS SYSTEMS AND APPLIANCES

Coachmen Industries is required to furnish the following consumer information as provided by the National Fire Prevention Association and the American National Standards Institute. The information and warnings found here may also be found in other sections of this Owner's Manual. Please see sections titled "Liquid Petroleum Gas System" and "Appliances" for other safety and operating information.

#### **WARNING!**

**LP gas containers shall not be placed or stored inside the vehicle. LP gas containers are equipped with safety devices which relieve excessive pressure by discharging gas to the atmosphere.**

#### **WARNING!**

**It is not safe to use cooking appliances for comfort heating. Cooking appliances need fresh air for safe operation. Before operation:**

1. Open overhead vent or turn on exhaust fan.
2. Open window.

**A warning label has been located in the cooking area to remind you to provide an adequate supply of fresh air for combustion. Unlike homes, the amount of oxygen supply is limited due to the size of the recreational vehicle, and proper ventilation when using the cooking appliance(s) will avoid dangers of asphyxiation. It is especially important that cooking appliances not be used for comfort heating as the danger of asphyxiation is greater when the appliance is used for long periods of time.**

#### **WARNING!**

**Portable fuel-burning equipment, including wood and charcoal grills and stoves, shall not be used inside this recreational vehicle. The use of this**

**equipment inside the recreational vehicle may cause fires or asphyxiation.**

#### **WARNING!**

**Do not bring or store LP gas containers, gasoline, or other flammable liquids inside the vehicle because a fire or explosion may result.**

A warning label has been located near the LP gas container. This label reads: **DO NOT FILL CONTAINER(S) TO MORE THAN 80 PERCENT OF CAPACITY.**

Overfilling the LP gas container can result in uncontrolled gas flow which can cause fire or explosion. A properly filled container will contain approximately 80 percent of its volume as liquid LP gas.

The following label has been placed in the vehicle near the range area:

#### **IF YOU SMELL GAS:**

1. Extinguish any open flames, pilot lights and all smoking materials.
2. Do not touch electrical switches.
3. Shut off the gas supply at the tank valve(s) or gas supply connection.
4. Open doors and other ventilating openings.
5. Leave the area until odor clears.
6. Have the gas system checked and leakage source corrected before using again.

LP gas regulators must always be installed with the diaphragm vent facing downward. Regulators that are not in compartments have been equipped with a protective cover. Make sure that regulator vent faces downward and the cover is kept in place to minimize vent blockage which could result in excessive gas pressure causing fire or explosion.

## INTRODUCTION

Congratulations on the purchase of your new Coachmen RV. We sincerely thank you for choosing our product. To help you enjoy it, you'll find in this owner's manual many useful tips for camping trips as well as basic operation and maintenance information for your RV's systems and appliances.

**TRY A SHORT TRIP FIRST.** The experience you will gain from this will help make your future RVing more enjoyable.

To complement the standard and optional equipment you've chosen for your unit, there are many other accessories available. You may wish to use your unit several times before you invest in these accessories. What may be a necessity for one RV owner could prove to be of no value to you. Remember, your dealer is always ready to help and advise you.

We go into great detail in this manual and for good reason. If you are a first-timer, we want you to learn to operate your RV correctly, to be able to use its components, appliances and any optional equipment in the most efficient manner.

At first glance, you may be overwhelmed by all the detail. But after you've used your new RV a couple of times, you'll be able to perform all the checks, start-ups and systems in much less time than it takes to read our instructions.

If you're a veteran RV owner, you know that things change and a quick review of this manual will bring you up to date on what's new.

So read on. Happy camping!

**Note:** *Because of individual tastes and the different floorplans offered, your RV may not have all of the components illustrated or described in this manual. Ask your dealer for details concerning the specifics of your unit.*

## LICENSES

Vehicle licensing laws vary from state-to-state. Check with your state license bureau or the nearest licensing branch office for the requirements of your state. Be sure to renew your driver's license if it has expired or will expire during your trip.

## INSURANCE

Personal liability, property damage, collision and theft of contents may be features of your automobile insurance policy that apply to your RV. Talk to your insurance agent about the details of your coverage. Always carry your insurance policy and/or card with you when you travel.

## TRAVEL PREPARATIONS

It's always a good idea to plan your trips. Make arrangements for someone to check your house periodically while you're on your trip. Stop mail and newspaper delivery. If you intend to be away for more than two weeks, request police surveillance for your house. Carry an extra set of vehicle and house keys with you on a separate key ring.

Fill your fresh-water tank before leaving. When traveling in winter, however, don't fill the water tank until the interior of your unit is thoroughly warmed or until you reach your destination.

Decide on the various items of equipment, clothing, food and other supplies you'll need for the length and destination of your trip.

Each moment you spend loading your RV is time you lose from the length of your stay. To reduce loading time, stock your RV with a supply of plastic or paper dinnerware, stainless steel or plastic flatware, pots, pans, towels and bedding. Try to use paper, plastic and aluminum whenever possible. They are lighter and less likely to break when the vehicle is moving. If you are planning an extended trip, pack only enough food for two or three days; you can replenish your supply along the way. Plan meals so that fresh or refrigerated items are used before they spoil. Keep a basic supply of seasonings (sugar, salt, pepper, spices) in your RV. See APPENDIX B: TRAVEL PREPARATION CHECKLIST for more tips on what to pack for your trip.

## GENERAL DRIVING CHECKS

For your safety, make certain that the following items have been checked and rechecked before you take your RV on the road. Be sure to read APPENDIX A: PRE-TRAVEL CHECK for additional driving checks.

**Hydraulic Levelers**—Must be raised as far as possible.

**Lights**—The following lights should be tested: brake lights, warning lights, flashers, clearance lights, taillights, headlights and instrument panel lights.

**Rearview Mirrors**—Adjust all rearview mirrors so that the driver can see the right and left side of the unit.

**TV Antenna**—Lowered.

## IMPORTANT DOCUMENTS

Always carry your vehicle registration, insurance policy card(s) and owner warranty registration card. If you are borrowing a vehicle, it is best to have with you a notarized letter of approval from the owner authorizing you to be in possession of the vehicle.

## COURTESY

Common courtesy will help make your stay more pleasant. Campsites often are close together and loud noises may disturb neighboring campers. Follow the posted rules of the campsite. Open fires might not be permitted. If you are permitted to build a campfire, clear

the area of all flammable materials; never leave a campfire unattended, and always make certain the embers are completely extinguished before leaving the campfire or before going to sleep.

## **TOURIST INFORMATION**

Obtain current road maps and tourist information for each state you'll visit or drive through. You also may want to purchase a tourist guide book and/or a campground directory.

If you will be visiting federally-operated national parks, monuments and recreation facilities, you might find the Golden Age Passport and/or the Golden Eagle Passport useful. These passports can help families cut expenses at areas where fees are involved.

**GOLDEN AGE PASSPORT** is a free lifetime pass for persons age 62 and over. It covers all admission fees and includes a 50 percent discount on usage fees (except fees charged by privately operated concessions). This passport is available only at park service offices and at parks where entrance fees are charged. It cannot be obtained through the mail or at post offices. To obtain the Golden Age Passport, you will need proof of age, such as a driver's license. (Medicare cards are not accepted as proof of age.) If you do not have adequate proof of your age, be prepared to sign an affidavit swearing that you are at least 62 years of age.

**GOLDEN EAGLE PASSPORT** is designed for persons who plan to visit in a single year several parks or federally-operated facilities. It covers all admission charges, but does not cover usage fees. It is good only during the calendar year in which it is issued. It may be purchased in person or through the mail from the National Park Service Headquarters, department of the Interior, Washington, D.C. 20240; at regional National Park Service offices, or at similar facilities where entrance fees are charged.

Both Golden Age and Golden Eagle Passports cover admission fees for passengers accompanying the permit holder. Where entry to the recreation facility is not by private vehicle, such passport covers only the permit holder and the permit holder's immediate family.

## **VISITING CANADA OR MEXICO**

The information in this section is general and is subject to change by the Canadian or Mexican government. For specific information, including rules for re-entering the U.S., as well as points of interest and campsites, contact the consulate nearest the point at which you plan to enter the country.

Passports or visas are not required for entry into Canada or Mexico. You must, however, carry your birth certificate, voter registration card, baptismal certificate or similar proof of identity when entering one of these countries. Naturalized U.S. citizens should carry their

naturalization papers or other proof of citizenship. Persons under 18 years of age should carry a notarized letter from their parents or guardians giving them permission to travel in Canada or Mexico.

**Note:** A U.S. driver's license does NOT serve as proof of identity.

No special driver's license or permit is necessary in either country; but, renew your license if it has expired, or will expire during the trip. Proof of vehicle ownership is required at the border. If you are using some else's unit, you should have a notarized letter authorizing its use.

## **MEXICO**

A tourist card is necessary for visiting in Mexico if you will be staying more than 72 hours or travel more than 40 miles from the border. Cards can be obtained at the port of entry or from a Mexican consulate.

### **VEHICLES**

Mexico requires a vehicle permit for every self-propelled vehicle. The permit can be obtained only from Mexican Aduana (customs) offices upon presentation of tourist card, vehicle registration and title or notarized statement from owner. Your insurance policy is **not** valid in Mexico. Temporary insurance must be purchased from Mexican companies (usually offices are located near the border).

### **CB RADIO**

Mexico currently prohibits the use of CB radios.

### **HUNTING AND FISHING**

Hunting and fishing laws in Mexico are extremely complicated. To request information, contact:

Secretaria de Comunicaciones  
Estados Unidos Mexicanos  
Mexico DF

### **DOGS AND CATS**

Mexico requires a certificate signed by a licensed veterinarian. The certificate should describe the pet and show that the pet has been vaccinated for rabies within the past six months. A fee is charged for the required verification of the certificate by a Mexican consulate.

## **CANADA**

### **VEHICLES**

Canada requires a Canadian Non-Residential Interprovincial Motor Vehicle Liability Insurance card, which is available only from U.S. agents. All provinces in Canada require evidence of financial responsibility if visitors are involved in an accident. Limits vary from province to province. Contact your insurance agent for details.

**CB RADIO**

CB radio operation in Canada requires a temporary license. To obtain such a license, write to:

Regional Director  
 Telecommunications Regulation Branch  
 Department of Communications  
 20th Floor  
 2085 Union Avenue  
 Montreal, Quebec H3A 2C3  
 Canada

**HUNTING AND FISHING**

Revolvers, pistols and fully-automatic firearms are prohibited in Canada. Each province has its own laws and licensing requirements. You must provide a written description and the serial number of each gun at the border. A license must be obtained from the province in which you intend to hunt or fish. Further information can be obtained by writing to the Department of Lands and Forests, Wildlife Branch, in the province you intend to visit.

**DOGS AND CATS**

CANADA requires a certificate signed by a licensed veterinarian in the U.S. or Canada stating that your dog has been vaccinated for rabies within the past twelve months. The certificate must contain a description of the dog and date of vaccination. Puppies under three months need no certificate. There is no restriction on the entry of healthy cats.

**LOADING**

A correctly loaded vehicle is necessary for safe operation. Distribute your cargo evenly from side-to-side and from front-to-back.

Heavier items should be stored as centrally as possible, on or near the floor. They should be secured so that they cannot slide during a sudden stop and cause damage. (Loose cargo can alter the balance you had when you started.) Lighter items can be stored in overhead cabinets or other areas. Remember to leave space and weight allowance for souvenirs and other items you may purchase during your travels. A properly loaded unit can help conserve fuel and can prevent excessive wear on your vehicle's automotive system.

**WEIGHT DEFINITIONS**

**GVWR** (GROSS VEHICLE WEIGHT RATING) is the maximum permissible weight of this fully loaded motorhome.

**UVW** (UNLOADED VEHICLE WEIGHT) is the weight of this motorhome as manufactured at the factory with full fuel, engine oil and coolants. The UVW does not include cargo, fresh water, LP gas, occupants or dealer installed accessories.

**SCWR** (SLEEPING CAPACITY WEIGHT RATING) is the manufacturer's designated number of sleeping positions multiplied by 154 pounds (70 kilograms).

**CCC** (CARGO CARRYING CAPACITY) is equal to GVWR minus each of the following: UVW, full fresh (potable) water weight (including water heater), full LP gas weight and SCWR. A sample Computation of the Cargo Carrying Capacity is included on the Weight Information Sheet.

**GCWR** (GROSS COMBINATION WEIGHT RATING) means the value specified by the motorhome manufacturer as the maximum allowable loaded weight of this motorhome with its towed trailer or tow vehicle. **Actual GCWR of this vehicle may be limited by the sum of the GVWR and the installed hitch rated capacity. See hitch rating label for detail.**

**GAWR** (GROSS AXLE WEIGHT RATING) is the allowable weight, including cargo, which can safely be supported by each axle.

**WEIGHT DETERMINATIONS**

It is extremely important that you weigh your unit before you leave on a trip. Check the Gross Axle Weight Rating (GAWR) and the Gross Vehicle Weight Rating (GVWR) found on the Federal Sticker and the unit weight information sheet affixed to each vehicle. The Federal Sticker or certificate lists the unit Serial Number and the front and rear GAWR and GVWR. It is located on the inside of the driver's door or to the left of the driver's seat.

We suggest that you record this sticker information in the space provided here to ensure that you always have the information close at hand.

GVWR \_\_\_\_\_ GAWR Front \_\_\_\_\_  
 GAWR Rear \_\_\_\_\_ with \_\_\_\_\_ tires  
 RIMS \_\_\_\_\_ at \_\_\_\_\_ PSI cold \_\_\_\_\_

MFD. BY:	DATE
INC. VEH. MFD. BY:	DATE
GAWR LB	TIRES
PSI COLD SINGLE	PSI COLD DUAL
RIMS	
FRONT	
INTER-MEDIATE	
REAR	
GVWR LB	MODEL NUMBER
TYPE	VEHICLE I.D. NUMBER
THIS VEHICLE CONFORMS TO ALL APPLICABLE FEDERAL MOTOR VEHICLE SAFETY STANDARDS IN EFFECT IN	

**FEDERAL STICKER**





## VEHICLE WEIGHING

STEP 1—Drive only the front wheels of the unit onto the scale. Compare the weight to the front GAWR listed on the Federal Sticker.

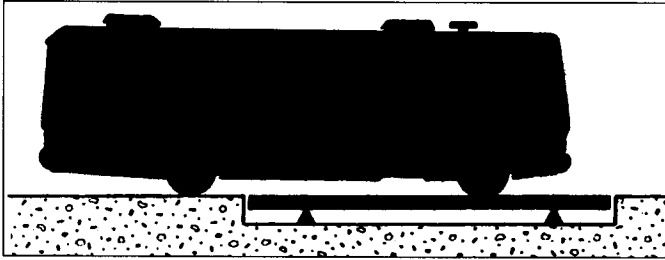

FRONT GROSS AXLE WEIGHT

STEP 2—Pull forward so that the front and rear axles are on the scale. Compare the weight to the GVWR listed on the Federal Sticker.

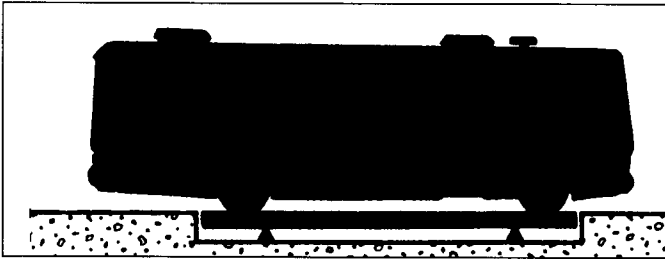

GROSS VEHICLE WEIGHT

STEP 3—Pull forward so that only the rear axle is on the scale. Compare the weight to the rear GAWR listed on the Federal Sticker.

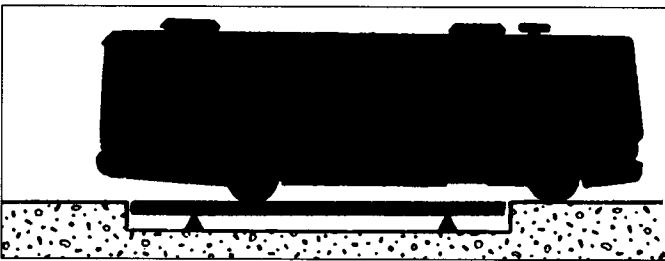

REAR GROSS AXLE WEIGHT

**Note:** If any of the weights exceed the listed rating, relocate the passengers and redistribute or remove a portion of the cargo until the weight is within the proper tolerance.

## TOWING

If your motorhome is equipped with an optional hitch towing package, do not exceed the Gross Combined Weight Rating (GCWR) as stated in the chassis manufacturer's owner's manual, or the rated capacity of the installed hitch (whichever is less).

## HITCH TYPES

### STANDARD

Class	Type	Max. G.T.W.	Max T.W.
I	Weight Carrying	2000 lbs	200lbs
II	Weight Carrying	3500 lbs	300 lbs
III	Weight Carrying	5000 lbs	500 lbs
IV	Weight Distributing	10000 lbs	1000 lbs
V	Weight Distributing	14000 lbs	1700 lbs

(G.T.W.=Gross Trailer Wt. T.W.=Tongue Wt.)

**Note:** Carrying capacities may vary by hitch manufacturer. The above chart is to be used as a guide only. Please consult the hitch manufacturer for more information concerning your specific needs.

## SEAT BELTS

Seat belts are an important safety feature of your vehicle. For your protection, fasten all seat belts while your motorhome is in motion. Adjust the belt low on the abdomen and as snugly as comfort will allow, for greatest safety. Never use a belt for more than one person at a time.

**Note:** All occupants should be furnished with and use seat belts while the vehicle is in motion. Do not occupy the beds while traveling as safety protection is not provided.

## INFANT AND CHILD RESTRAINTS



For maximum protection in your unit children should not be transported unrestrained. Infants should be placed in infant carriers. Small children should be restrained in child safety seats. These seats should be placed in the vehicle in accordance with the instructions with the seat or infant carrier.

## CLEARANCE

Be sure to read "Clearance Height" signs on overpasses, drive-through windows, etc. Watch out for overhanging tree branches, awnings or similar obstructions that can damage your vehicle's roof or roof-mounted equipment and accessories. Check with your dealer for clearance measurements of the unit.

## MIRRORS

Make sure mirrors are positioned properly for best vision. Mirrors obviously are important for more than just backing. RV drivers should learn to check traffic conditions to the rear frequently, even when cruising wide-open highways, to avoid surprises.

### REMOTE MIRRORS

This option allows you 4-way directional setting without leaving your captain's chair. This switch is located on your dash.

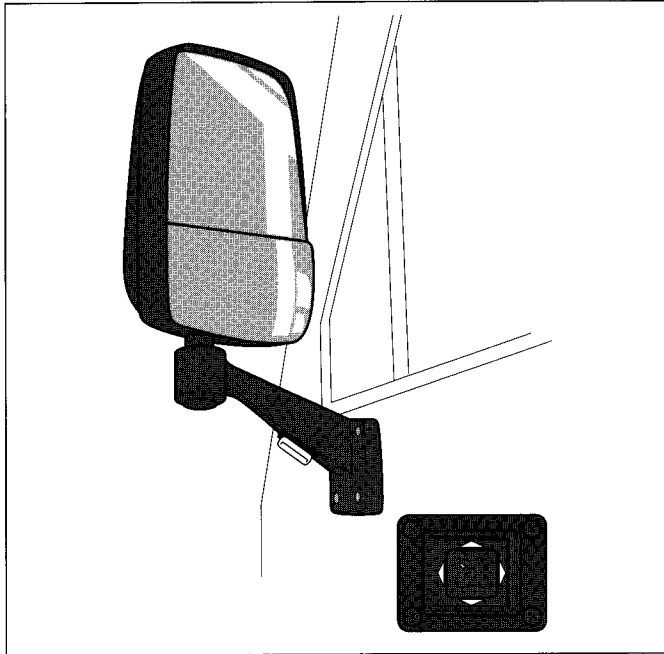

REMOTE MIRRORS

### PULLING INTO TRAFFIC

One of the most important safety practices for the RV driver is to make directional changes slowly. A rapid lane change may cause an accident, but a very-deliberate lane change permits the other driver to give a blast on his horn, and/or take evasive action. Check for oncoming traffic in all directions. Signal before entering the flow of traffic. Always accelerate slowly and smoothly; the weight of your motorhome makes quick acceleration not only difficult but potentially unsafe.

### BRAKING

Allow a safe distance to stop; follow no closer than one vehicle length for each 10 mph. Pump the brake pedal lightly to stop on wet or icy roads. If you start to slide, turn the wheel in the direction of the slide. Do not "slam on" the brakes; a sudden stop may increase the slide.

Gradual braking, permitted by keeping good distance between vehicles, helps prevent rear-end collisions.

Added weight requires increased braking distances, and motorhome owners must be particularly aware of brake fade hazards. Brake fade is overheating of brake surfaces to the point where friction is greatly diminished, or lost. The result is a brake pedal that is firm to the foot, but produces little or no stopping action.

Proper use of brakes will prevent fade. It normally occurs while traveling downhill grades that require frequent brake application in order to hold speed to the desired level. In an RV, the brakes may become superheated after several applications and an accident may occur. To avoid this problem, use lower gears to retard vehicle speed to the point where only occasional brake application is necessary.

### UPGRADES

To avoid engine overheating when climbing a steep grade, reduce speed and shift the transmission to a lower gear.

Because RV's climb hills more slowly than most passenger cars it's important to practice good manners and avoid holding back faster traffic. Not only does it improve the image of the RV owner, it reduces hazards.

Also, it's simply good manners to drive slightly to the right, so other drivers can more easily see around your motorhome. The RV owner who hugs the center line tends to create animosity behind him.

### DOWNGRADES

When you are going downhill, reduce your speed and shift the transmission to a lower gear to assist in braking on long or steep downgrades.

### PASSING

Avoid sudden maneuvers when passing a slower-moving vehicle. Remember that additional time and distance are required to pass safely. Wait until the road is clear of oncoming traffic for at least 1/2 mile. Check the outside rearview mirrors and signal lane changes before passing other vehicles. When you have safe clearance, signal lane change and return to your original lane.

### SWAYING OR FISHTAILING

If this happens while you are towing a vehicle, accelerate slightly and then gradually slow down. If your unit still sways, pull off the road and check the following:

1. towing equipment,
2. distribution of cargo,
3. tire pressure, and
4. motorhome front-end alignment and suspension.

### CROSS WINDS

When traveling against strong cross winds, it is best to reduce speed. Remember to steer slightly into the wind when you feel your RV drifting with the cross wind. The key is not to oversteer in this situation.

### TURNING

Pull several feet farther ahead before turning. This will compensate for the extra width and length of your motorhome and will help you avoid hitting curbs or parked vehicles.

## BACKING

Remember that your motorhome is higher, wider and longer than other vehicles you may own, so it is extremely important that you back the unit slowly. Because visibility is somewhat restricted, backing the unit may require stationing someone beside the unit to guide the driver.

## OVERHEATING

If your motorhome's engine overheats, pull well off the road. Shift to Park (P) and run the engine with your foot resting lightly on the accelerator pedal. If the engine does not cool within 2 to 3 minutes, turn it off and locate the problem.

Engine temperature problems may be avoided if you climb long grades and descend moderately steep grades in second gear; climb steep grades in first gear and if your unit has auto air conditioning, turn it off.

### \* CAUTION \*

*DO NOT exceed the maximum speed listed in the chassis manufacturer's manual for first and second gear—excessive engine speed will overheat the transmission, which may cause early transmission failure.*

## PARKING ON A GRADE

Parking vehicles on an upgrade or downgrade is not recommended. If it is necessary in an emergency, always apply the foot brake, then set the parking brake before moving the shift lever to Park (P). When preparing to move the vehicle, move shift lever out of Park before releasing the parking brake. If this sequence is not followed, you may not be able to move the shift lever out of Park. If this torque lock does occur, you may need to have another vehicle assist you in relieving the pressure on the shift lever. On severe grades it may be necessary to have a passenger place wheel chocks behind the tires of your motorhome.

## PARKING ON AN UPGRADE

Use the foot brake or parking brake and Park (P) position to hold the vehicle on an upgrade. Using a driving gear to hold the unit may cause the engine or transmission to overheat. **DO NOT** idle the engine for more than one minute with the transmission in gear.

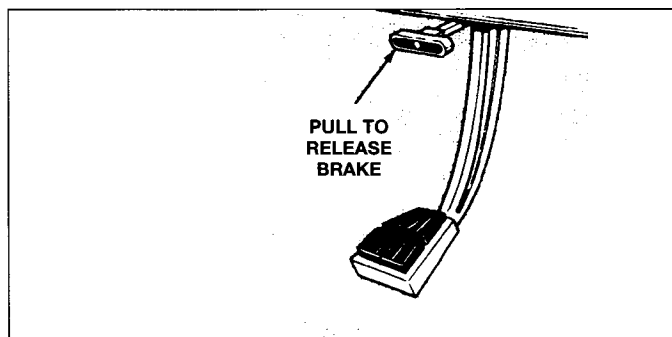

Chevy has a park brake lever.

Ford park brake automatically works when transmission is shifted to Park (P) position.

## FREING A STUCK VEHICLE

To pull your vehicle out of the snow, sand or mud, apply slight pressure to the accelerator pedal and move the gear selector lever rhythmically between first gear and Reverse (R). If possible, keep the front wheels pointed straight ahead. Avoid sharp turns. Once the unit starts to move, do not stop until it is on firm ground.

### \* CAUTION \*

*DO NOT race the engine or spin the wheels; prolonged efforts to free a stuck vehicle may result in overheating and transmission and axle failure.*

## SPEED CONTROL

Your motorhome is equipped with a cruise control device, which automatically controls speeds at over 30 mph. The type of speed control will vary with the chassis type and chassis model year.

The speed controls may be on the turn signal lever or on the spokes of the steering wheel. Despite the varying locations, the basic operation of each is similar. However, certain speed control devices have specific differences, so it is important that you very carefully read the instructions in the chassis manufacturer's owner's guide.

### \* CAUTION \*

*DO NOT use any auto speed control when conditions are not suitable for maintaining a constant speed, such as in heavy or varying traffic, in strong winds, or on slippery, winding or unpaved roads. Never shift to Neutral (N) when using the speed control; it will cause the engine to over-speed. Use only properly installed, FCC-approved radio transmitting equipment (such as CB radios). Use of other transmitting equipment may cause the cruise control to malfunction.*

## EMERGENCY START SWITCH

Your vehicle will be equipped with an emergency start switch located on the dashboard. This switch allows you to switch to the coach battery to start the engine in the event of low chassis battery. To activate the emergency start, simply push and hold the switch, then start the engine. Once the engine is started, release the switch.

## TIRE CHANGE

Change a tire on as level and firm a surface as possible. If you are on the roadside, activate the vehicle's hazard warning flashers. Apply parking brake and move transmission selector to Park (P). Set up flares and/or warning lights. See the chassis manufacturer's owner's manual for specific jacking and tire removal and replacement instructions which pertain to your unit. Stop at the nearest service facility and have the torque checked.

**\* CAUTION \***

Never place the jack under a bumper or edge of the sidewall. On units equipped with tag axle, never place the jack under the tag axle. Use the jack only for changing tires. Never get underneath the vehicle when using the jack; never start or run the engine while vehicle is on the jack. Always securely stow the spare tire in the specified location and return all jacking equipment to its proper storage area.

### RECOVERY TOWING ON THE ROAD

If your motorhome needs to be towed the following guidelines should be used:

1. The vehicle **MUST** be towed only from the front. See **Chassis Operators Manual**.
2. Be prepared to give the tow truck operator at least the following information when you call:

*Length and height of motorhome.*

*Chassis Manufacturer gross vehicle weight rating.*

*Axle weight ratings.*

(This information is found on the vehicle certification label located to the left of the drivers seat.)

3. It is recommended that you ask for an **UNDERLIFT** (wheel lift or frame lift) type towing assembly for safe towing.

#### To prepare your motorhome for towing:

1. Secure any loose protruding body parts of the disabled vehicle.
2. Secure any heavy loose items in the interior.
3. Turn off all LP gas appliances and LP gas tank valve.
- 4 Do not allow any person to ride in the towed vehicle.

### EMERGENCY TOWING

**\* CAUTION \***

Do not allow your motorhome to be towed without having the tow truck operator read this section and related sections of the **Chassis Operators manual**.

Coachmen Industries does not assume responsibility for damage incurred while towing this vehicle.

## DASH INSTRUMENT CONTROLS

Your motorhome automotive instruments and controls are designed for convenience and safety. Since dashboards will vary depending on model and options chosen, read the chassis manufacturer's owner's manual for complete details on operation and maintenance of the systems. The illustrations shown on page 16 are for reference only. Your Coachmen dealer will be happy to acquaint you with the controls in your unit.

### TILT STEERING WHEEL

If your unit is equipped with a tilt steering wheel, it can be moved to allow additional room for entrance and exit, as well as selected driving positions.

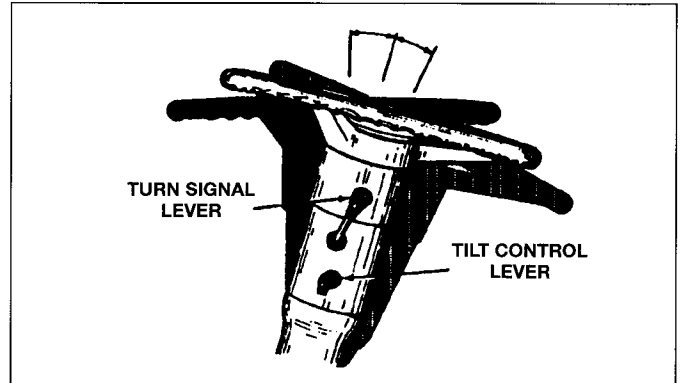

TILT STEERING WHEEL—TYPICAL

Operate the tilt mechanism by lifting the small control lever on the left side of the steering column just below the directional lever incorporated into the signal lever). Move the steering wheel to the desired position and release the lever to secure in place. Do not adjust steering position while the vehicle is in motion.

## CAMPING

### CAMPSITE SELECTION

There are many campground guides that will assist you in making your selection. Many campgrounds accept reservations, and during peak seasons, it is wise to make a reservation. If possible, arrive early so you can inspect and choose your campsite during the daylight hours.

During the winter months it is desirable to take advantage of natural windbreaks like trees, bushes or any similar type of windbreak. This will cut down the possibility of cold drafts that can affect the comfort level of your unit.

### SET-UP

It is very important that your unit is level. This allows your refrigerator and drainage systems to operate properly (both function by gravity). To determine levelness, place a level on the bottom of the refrigerator's freezer compartment or in a normally level location inside the vehicle. You may wish to permanently attach levels (available at your dealer) on the front and/or back and sides of the RV. This will allow you to tell at a glance if you've stopped on a level site and will help speed the leveling process.

### LEVELING

If the unit needs side-to-side leveling, make a step leveling ramp on the low side out of 1 x 6" or 2 x 6" boards of varying lengths. Pull the unit forward or back onto the leveling ramp until the tire(s) on the low side is level. Many experienced RVers carry level boards or blocks in their unit for this purpose

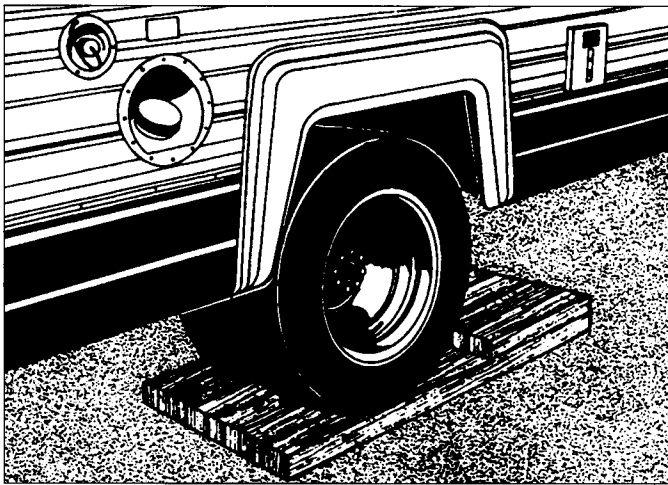

STEP LEVELING RAMP

## HYDRAULIC LEVELERS

### LEVELING PROCEDURE

1. Place gear selector in the parking position, apply park brake and block tires securely.

**NOTE:** If the hand/auto park brake is not set, the "NOT IN PARK/BREAK" light will come on when the "ON" button is pushed. The panel will turn on, but the system will not operate.

2. Turn ignition switch to "ACCESSORY".
3. Push the "ON" button on the touch panel. The POWER ON light will be lit. Place pads under the jacks, if necessary, at this time.
4. A lit yellow LEVEL light indicates that end or side is low. Push a RAISE (up arrow) button to extend jack pairs according to lit yellow lights. ALWAYS LEVEL THE VEHICLE FROM SIDE TO SIDE BEFORE LEVELING THE VEHICLE FRONT TO REAR. Two yellow LEVEL lights can be on at one time. Extend jack pairs accordingly until all yellow lights are out. If the ground is too uneven, the jacks may not have enough stroke to level the vehicle. The vehicle may have to be moved.
5. After the vehicle is level, the jacks not used for leveling may be extended until they touch the ground. This provides additional stability against wind and activity in the vehicle. Do this by pushing the front and/or rear RAISE buttons as needed to extend any remaining jacks. Do not use the right or left RAISE buttons.
6. Push the "OFF" button on the touch panel.
7. Turn the ignition switch off.

**NOTE:** The leveling system should be cycled once a month or whenever the vehicle is used, to keep the system in operating condition.

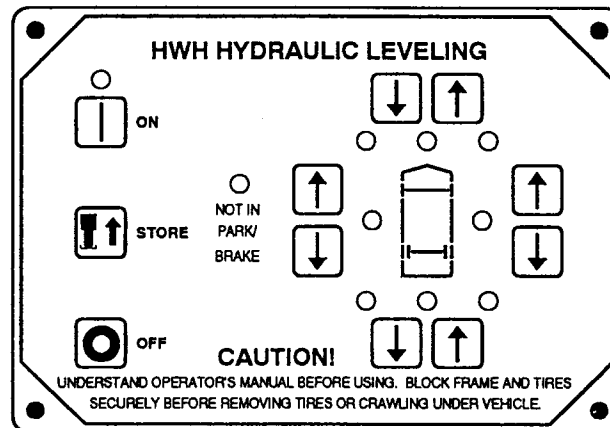

### CONTROL FUNCTIONS

#### CONTROL BUTTONS

**"ON" BUTTON:** This is the "ON" button for the leveling system. It provides control power to operate the electrical relay on the pump, the leveling lights and the 4 red warning lights.

**"OFF" BUTTON:** This button turns off control power to the leveling system.

**"STORE" BUTTON:** This button will retract all four jacks at the same time.

**EXTEND BUTTONS (UP ARROWS):** These buttons will extend their respective jack pairs to lift the vehicle.

**RETRACT BUTTONS (DOWN ARROWS):** These buttons will retract their respective jack pairs to lower the vehicle.

#### INDICATOR LIGHTS

**POWER LIGHT:** This light indicates the system is on.

**STORE LIGHT:** This light will be on when the system is in the store mode.

**NOT IN PARK/BRAKE LIGHT:** This indicator light is on when the panel is on, but the hand/auto park brake is not set.

**LEVELING LIGHTS:** If a yellow LEVELING LIGHT is on, that indicates a side, corner, or end of the vehicle is low. Extend the appropriate jack pairs to put out the yellow light. Only one yellow leveling light can be on at a time. The vehicle is level when all yellow lights are out.

**"WARNING LIGHTS":** A red "WARNING" light will be on whenever the corresponding jack is extended approximately 2", provided the ignition is in the "ACC" or "ON" position and the system is on. Some vehicles are equipped with a dash mounted master "JACKS DOWN" light which will be on when one or more jacks are extended approximately 2".

**"WARNING BUZZER":** A buzzer will sound if a jack is extended 2 inches more and the ignition switch is in the "ON" position.

## RETRACT PROCEDURES

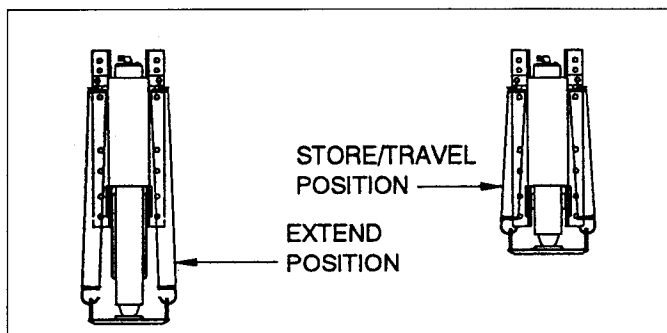

FIGURE 3

### \* CAUTION \*

THE OPERATOR MUST BE SURE THAT THERE ARE NO OBJECTS UNDER THE VEHICLE AND THAT ALL PEOPLE ARE CLEAR OF THE VEHICLE.

1. Turn the ignition switch "ON" and press the "ON" button one time. The ON indicator light will glow steady.
2. Press the "STORE" button. As each jack retracts, its red WARNING light will go out. The vehicle can be moved as soon as the red WARNING lights are out, provided the jacks are in the STORE/TRAVEL position. (See Figure 1)

**IMPORTANT:** DO NOT interrupt power to the leveling system while it is in the STORE mode. DO NOT push the "OFF" button or turn the ignition key. The system must be allowed to completely finish the STORE mode. If the engine was started before putting the system in the STORE mode, the vehicle may be moved when the jacks are in the "STORE" position. This will not interrupt the store procedure.

### \* CAUTION \*

DO NOT MOVE THE VEHICLE WHILE THE LEVELING JACKS ARE STILL IN CONTACT WITH THE GROUND OR IN THE EXTEND POSITION. THIS VEHICLE IS EQUIPPED WITH STRAIGHT ACTING JACKS. MOVING THE VEHICLE WITH THE LEVELING JACKS EXTENDED CAN CAUSE SEVERE DAMAGE TO THE JACKS AND/OR THE VEHICLE AND CREATE A DRIVING HAZARD. DO NOT RELY SOLELY UPON WARNING LIGHTS. IT IS THE OPERATOR'S RESPONSIBILITY TO CHECK THAT ALL JACKS ARE FULLY RETRACTED INTO THE STORE/TRAVEL POSITION.

3. The system will automatically shut down approximately two minutes after the four individual red WARNING lights are out.
4. Turn the ignition switch to the "OFF" position or proceed to travel.

**NOTE:** If jacks cannot be retracted by the above procedure see MANUAL JACK RETRACTION section.

## MANUAL JACK RETRACTION

**NOTE:** Use the valve release "T" for retracting only if the "STORE" button on the control panel will not retract the jacks for travel.

### \* CAUTION \*

KEEP AWAY FROM THE WHEELS, DO NOT CRAWL UNDER THE VEHICLE, KEEP A SAFE DISTANCE IN FRONT AND REAR OF VEHICLE. THE VEHICLE MAY DROP AND/OR MOVE FORWARD OR BACKWARD WITHOUT WARNING AS THE VALVE RELEASE IS OPERATED.

1. Locate the 4 valve release "T" handles on the solenoid valves. The solenoid valves are located on the pump/valve assembly.
2. Allow clearance for vehicle to lower.
3. Retract the rear jacks by opening the two outer valves. Slowly turn the "T" handles counter clockwise. The handles may turn easily at first but as an internal spring is compressed, turning may become more difficult. The valves need only to be opened enough to retract the jack.
4. Retract the front jacks by opening the two center valves as described in step 3.
5. Check that all four jacks are now retracted.
6. Close the valves by turning the release handles clockwise.

Once the internal spring tension has been released, the handles will turn free for several turns. Once the "T" handles are snug, DO NOT tighten the handles past this point as internal damage may occur to the solenoid.

7. The system should now be repaired before using again.

## SLIDE OUT ROOM OPERATION (HYDRAULIC)

**KEY SWITCH:** The KEY SWITCH controls power to the ROOM CONTROL SWITCH. When the KEY SWITCH is in the "ON" POSITION the room can be operated, and the key cannot be removed. When the KEY SWITCH is in the "OFF" POSITION the room cannot be operated, and the key can be removed.

**ROOM CONTROL SWITCH:** The ROOM CONTROL SWITCH is a two position momentary switch. Pressing the switch in the EXTEND POSITION will extend the room. Pressing the switch in the RETRACT POSITION will retract the room. Releasing the ROOM CONTROL SWITCH will halt the operation of the room.

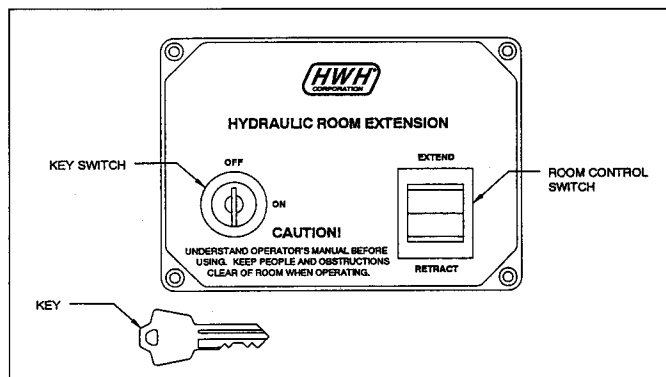

HYDRAULIC SLIDE OUT ROOM OPERATOR'S PANEL

## ROOM EXTEND PROCEDURE

**Note:** The parking brake must be set and the jacks must be extended before a room can be extended or retracted.

### \* CAUTION \*

Operating the room with any room-locking devices locked or the manual retract winch attached can cause personal injury and vehicle damage. It is the operator's responsibility to ensure that all room-locking devices and the manual retract winch are disengaged before operating the room.

1. Unlock and remove all room-locking devices.

**Note:** If the manual retract winch is attached to the room it must be removed before extending the room. Make sure there is adequate clearance to fully extend the room.

2. Battery disconnects must be on.
3. Set emergency brake. The system will not operate without the brake set.
4. Turn vehicle ignition switch to the accessory position.
5. Turn hydraulic leveling jacks on, level unit.
6. Insert key and turn switch to the on position. The hydraulic leveling jack control panel must be in the on position.
7. Press and hold the room control switch in the "extend" position. When the room is fully extended, release the room control switch.

**Important:** Do not hold the room control switch in the "extend" position for more than ten seconds after the room is fully extended, or stops moving. If either side of the room stops moving, release the room control switch immediately.

**Note:** Releasing the room control switch will halt the operation of the room.

8. Turn room key switch to the off position.
9. Remove the room key from switch to prevent undesired operation of the room.

10. Turn hydraulic leveling jacks off.

11. Turn the ignition key off.

## ROOM RETRACT PROCEDURE

**Note:** The parking brake must be set and the jacks must be extended before a room can be extended or retracted.

### \* CAUTION \*

Keep people and obstructives clear of room when operating the slide out room.

1. Turn the vehicle ignition key to the accessory position.
2. Turn on the hydraulic leveling jacks
3. Insert room key and turn key switch to the "on" position.
4. Press and hold the room control switch in the retract position. When the room is fully retracted, release the room control switch.

**Important:** Do not hold the room control switch in the "retract" position for more than ten seconds after the room is fully extended, or stops moving.

**Note:** Releasing the room control switch will halt the operation of the room.

5. Turn the room key switch to the off position.
6. Remove the room control key to prevent undesired operation of the room.
- Note:** Remember, the hydraulic jacks must be retracted before moving the vehicle.
7. Turn hydraulic jacks off.
8. Turn ignition key off.
9. Engage all (if equipped) room locking devices
10. If the room will not retract, see the manual room retract procedure

## A TYPICAL MANUAL RETRACT STRAP LOCATION

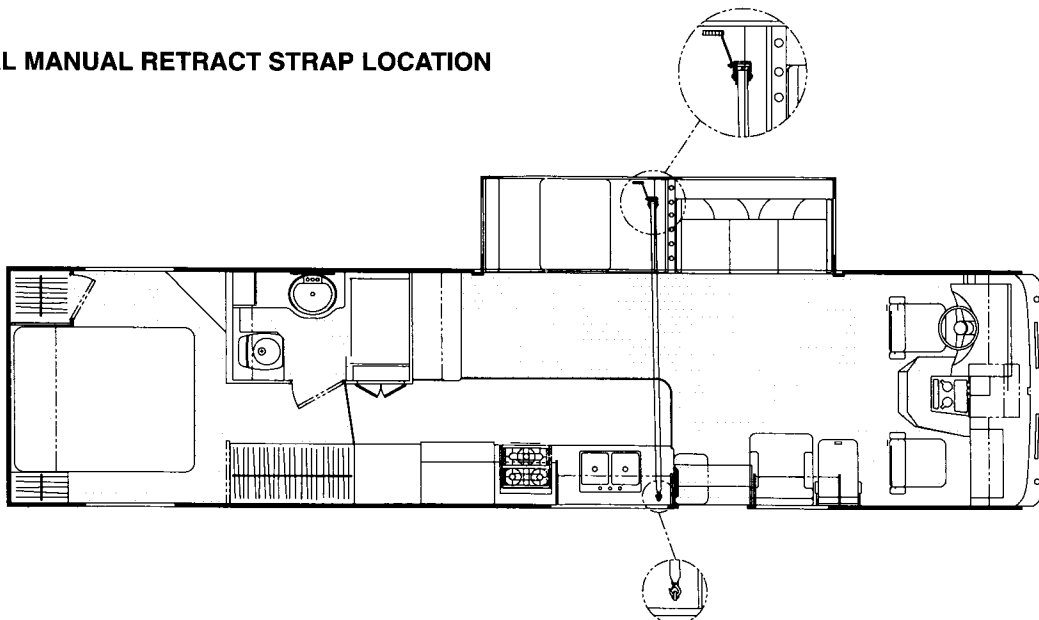

## MANUAL ROOM RETRACT PROCEDURE

Use only when the room will not retract with the room control switch.

The room can be retracted manually if a hydraulic or electrical failure prevents the room from being retracted using the ROOM CONTROL SWITCH. For normal retract sequences see the ROOM RETRACT PROCEDURE.

### \* CAUTION \*

The manual retract winch is equipped for manually retracting the room only. It is not to be used for lifting or any other application.

High forces are created when using a winch, creating potential safety hazards. Failure to follow all cautions and instructions may cause failure of the manual retract winch or connections resulting in Damage or personal injury.

Maintain firm grip on the winch handle at all times. never release the handle when ratchet lever is in the off position and the winch is loaded. The winch handle could spin violently and cause personal injury.

Check the winch and straps for damage or wear, and check for proper ratchet operation on each use of the winch. Do not use if damaged or worn.

1. Retract jacks following the LEVELING SYSTEM RETRACT PROCEDURE.

**Note:** Under normal operation jacks are retracted after the room is retracted. When manually retracting the room, the jacks are retracted before the room.

2. Locate the HYDRAULIC PUMP/MANIFOLD unit.

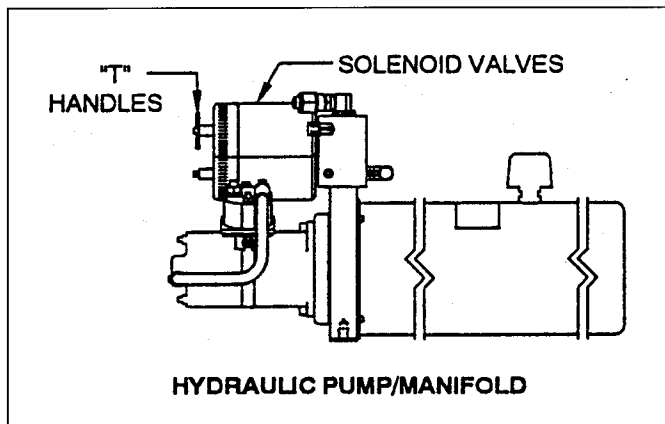

3. Open the SOLENOID VALVES by turning the "T" HANDLES counterclockwise.

**Note:** The "T" HANDLE may turn easily at first but will become more difficult to turn as an internal spring is compressed. Be sure to open both valves completely (about six turns of "T" HANDLE.)

**Note:** The room may move slightly as the solenoid valves are opened and internal pressure is released.

4. Locate the MANUAL RETRACT WINCH and connect it to the room according to the vehicle manufacturer's instructions. To extend the WINCH STRAP firmly grasp WINCH HANDLE, place RATCHET LEVER in

its OFF position, and slowly rotate the WINCH HANDLE counterclockwise, keeping a firm grip on the handle. When enough WINCH STRAP is extended, place the RATCHET LEVER in its ON position and slowly rotate the WINCH HANDLE clockwise until the RATCHET LEVER locks.

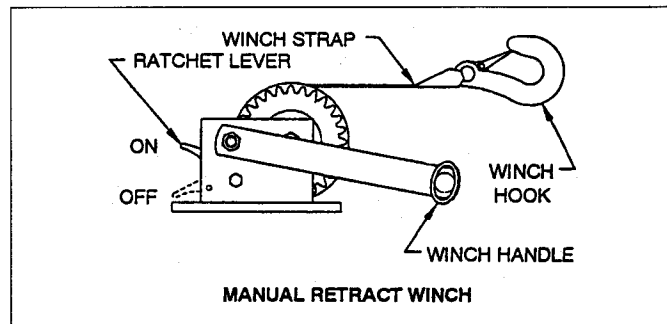

5. Slowly winch the room in by turning the WINCH HANDLE clockwise. The RATCHET LEVER should produce a loud sharp clicking noise.

**Note:** Winching the room in quickly will raise pressure in the hydraulic fluid and make winching more difficult.

### \* CAUTION \*

Operate the manual retract winch by hand power only. If the winch cannot be cranked easily with one hand it is probably overloaded. If winching becomes too difficult stop and check for obstructions or restrictions on the room and room extension mechanism.

6. When the room is fully retracted, engage the room locking devices. Leave the retract winch in place.

### \* CAUTION \*

The room extension solenoid valve "T" handles must be in the open position when the manual retract winch is engaged.

7. The system should be repaired before using again.

## SLIDE OUT ROOM OPERATION (ELECTRIC)

### OPERATING PROCEDURE

Make sure the coach is on level ground with the emergency brake set. Check side clearance. Lower and adjust the stabilizing jacks. Extend the slide-out room by pressing the activator button. Press the button only once, and do not hold the button in the depressed position. Movement of the room may be stopped or reversed by pressing the activator button.



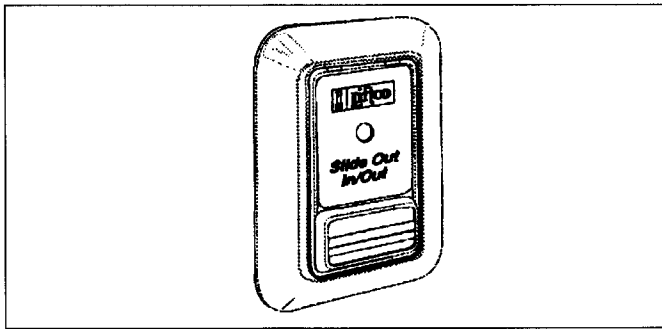

ELECTRIC SLIDE OUT ROOM OPERATOR'S PANEL

### ROOM RETRACT PROCEDURE

**Note:** The parking brake must be set before a room can be extended or retracted.



Keep people and obstructions clear of room when operating the slide out room.

Check the interior and exterior areas for obstructions. Insure that no one is inside the slide-out room. Depress the activator button once. Movement can be stopped or reversed by pressing the activator button. After the slide-out room is in position fully retract the stabilizing jacks.

### MANUAL ROOM RETRACT PROCEDURE

Use only when the room will not retract with the operator's panel.

The room can be retracted manually if an electrical failure prevents the room from being retracted using the operator's panel. For normal retract sequences see the ROOM RETRACT PROCEDURE.

In the event of a loss of electrical power or malfunction the slide-out room is equipped with a manual over ride. To operate the manual over ride check the interior and exterior areas for obstructions. Locate and remove the manual over ride plug on the exterior sidewall of the slide-out room. Insert the supplied hand crank. Turn the crank clockwise to close, and counter clockwise to extend the room.

## LIVING AREA

### AIR QUALITY

State-of-the-art construction and energy conservation methods have been used in manufacturing your Coachmen RV. These improvements have substantially reduced air infiltration and air exchange, making them almost airtight. Therefore, regular airing of your unit is recommended, especially during periods of high temperature and high humidity, and after prolonged storage.

### CONDENSATION

Condensation can be a problem in modern, tightly-constructed, well-insulated RVs. Certain amounts of condensation should be expected, especially on cool surfaces such as windows, roof vents, and metal door frames. However,

when there is excessive condensation—the troublesome kind that blocks all windows with fog or frost—damage to walls, woodwork and ceilings can occur. Remember—sweating windows are a signal indicating that moisture is trying to get out to mix with drier air.

### CONTROLLING CONDENSATION

When your unit is closed tightly, especially in cold weather, the small air volume in the RV can absorb only a certain amount of moisture. Bathing, dish washing and laundry appliances are among the causes of excessive moisture in the air. You can control the amount of moisture in the air by allowing the moisture to escape to the outside. Use your vent hood and fan when you cook; keep bathroom door closed and the vent or window open while you bathe or shower (and for a short time after you have finished bathing or showering, to allow all the moisture to dissipate); don't hang wet clothes in your unit.

### CARBON MONOXIDE DETECTOR

This option detects Carbon Monoxide well below the 15% Carboxyhemoglobin blood levels, and will alarm long before any health hazard occurs.

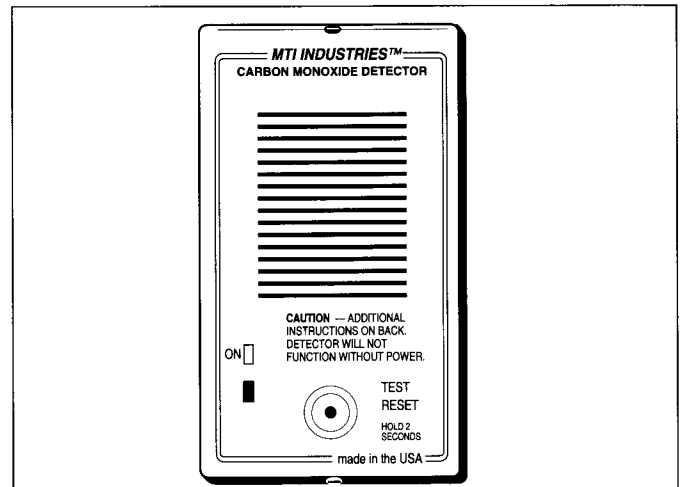

### TABLES

Listed below are general instructions for setting up the variety of tables and beds that may be found in your RV. Your dealer will be happy to demonstrate these items.

#### SWING UP TABLE

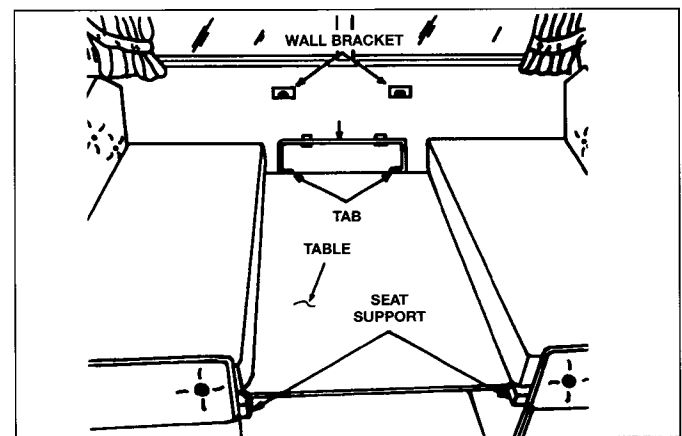

SWING UP TABLE

To raise the swing up table, pull the table toward you and up; then push it toward the wall. Insert tabs at back of table into the wall brackets. Pull the leg down and adjust to the proper height. To lower the table into the bed position, reverse the above operation.

### LOUNGE TABLE

Lift lounge table from its storage location behind the cabinet. Lay it in position across the top of the cabinet. Some pull-up tables have extension leaves.

### PEDESTAL TABLE

Insert table leg into base plate. Lower table support bracket onto the leg.

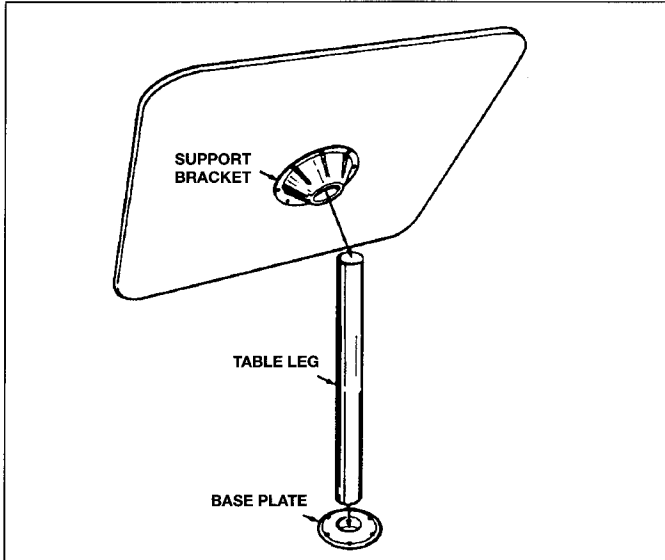

PEDESTAL TABLE

## BEDS

### DINETTE BED

For those with swing tables, move the leg to the UP position and pivot the table down to the dinette seat supports. Place the table on the seat braces and arrange the cushions on the top.

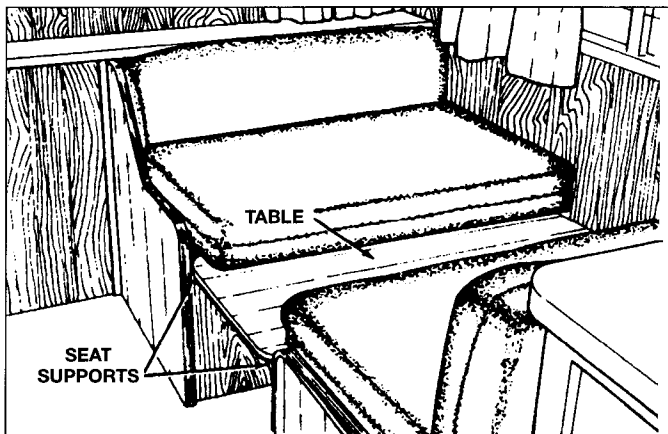

DINETTE BED

## SOFA

Several types of sofas are used. Talk to your dealer for proper instructions for the sofa in your particular unit.

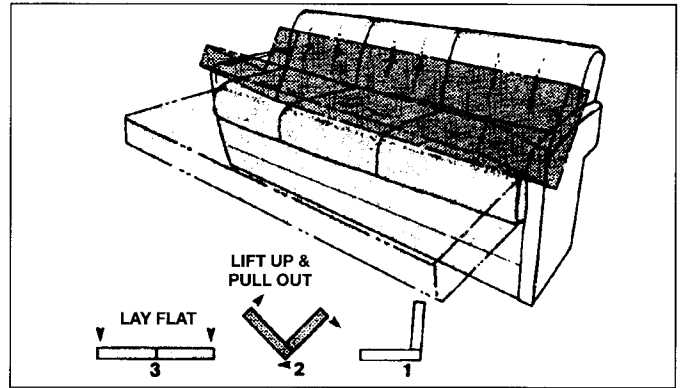

JACKKNIFE SOFA

### DRIVER AND PASSENGER CHAIRS

Some driver and passenger chairs slide, swivel and recline; others may slide and swivel or slide only. Have your dealer demonstrate the operation of the chairs in your unit. The captain's chair illustrated slides forward and backward, swivels and reclines in many positions

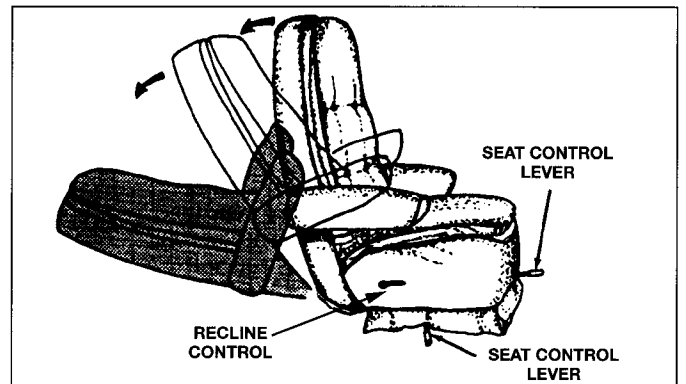

CAPTAIN'S CHAIR

To move the seat forward or rearward, pull lever located under the front left side to the left, then slide the seat in desired direction. To swivel the seat, push back on the lever under the seat on the right side and turn to desired position. The chair reclines in infinite positions by the recline control. Swing armrests up or down as desired.

### BARREL CHAIRS

To swivel mechanically operated barrel chair, push down on the lever located on the right side of seat and turn seat to desired position. To slide the seat, pull lever located at left front and move seat forward or backward.

### DIVIDER DRAPES

A divider drape, to separate the driving area or bath from the living area, is installed in some models. the drape slides along a ceiling track. When open, it can be attached to the unit's side, behind the driver or at the door frame with a tieback.

The optional windshield drapes are designed to provide privacy when parked and slide along a track over the sun visors. The drapes meet in the center of the

windshield when closed. Secure with tiebacks on either side of the unit when open.

## BASIC UTILITY SYSTEMS

This section will describe the four basic utility systems found in your motorhome. They are: Electrical, Fresh Water, Drainage/Sewer and LP Gas. The following will familiarize you with their function, operation and simple maintenance. If a problem should develop with any of the systems, contact your dealer.

Only qualified personnel should perform service or repair on systems or components which affect safety including:

1. The LP System and Appliances
2. The Electrical System and Appliances
3. Running Gear and Suspensions &
4. Exhaust Systems

**Failure to comply with acceptable working procedure may cause fires, explosions, or other life threatening situations.**

Replacement parts should be at least equal to the original components.

### MONITOR PANEL

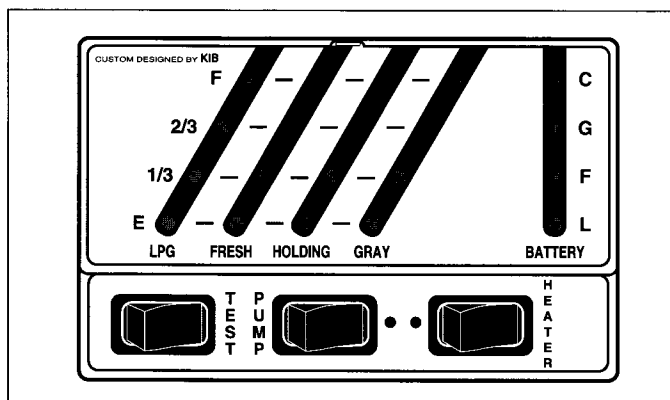

MONITOR PANEL (TYPICAL)

Your motorhome is equipped with a monitor panel that allows you to check the condition of your RV battery and the volume of fresh, waste and gray water in your unit's holding tanks. It also will monitor LP gas and includes switches for the water pump and water heater. Your monitor panel will be located on the wall. Your dealer will be happy to explain the operation of your monitor panel.

### BATTERY CONDITION LEVELS

The battery condition will fall into one of the following levels:

- C** Converter, more than 14.5 volts (unfiltered circuit or dead cells in battery).
- G** Good, 12.6–14.49 volts.
- F** Fair, 12.0–12.5 volts.
- L** Low, 5–11.9 volts.

### ELECTRICAL SYSTEM

Your motorhome contains two (2) separate electrical systems: one 12-volt direct current (DC) and one 120-volt alternating current (AC), similar to the one in homes.

These systems provide you with power while you are camped or are traveling. The 120-volt system requires an external source of 120-volt electricity, usually a campsite or household receptacle or an auxiliary generator. The 12-volt electrical system is supplied by batteries, the power converter or the 12-volt source from the automotive chassis.

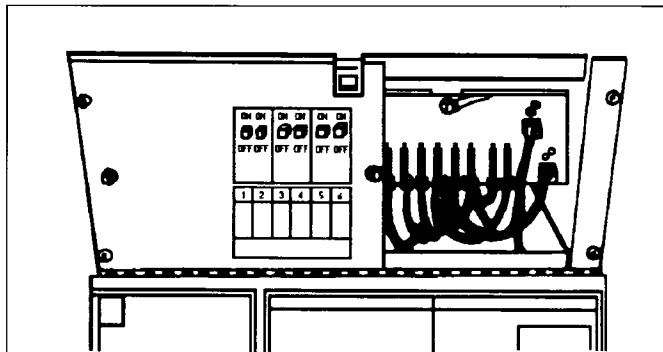

**COMBINED POWER CENTER/CONVERTER**  
Operational instructions are located inside power center door

To reduce the 12-volt load on your RV battery, the 120-volt system should be used whenever a 120-volt hook-up is available. Although most components in your unit (water pump, range hood light and fan, interior lights) operate only from a 12-volt source, the power converter changes 120-volt AC to 12-volt DC power.

### POWER DISTRIBUTION CHART

CHASSIS BATTERY	POWER CENTER AND/OR 12-VOLT BATTERY	120-VOLT ELECTRICAL
Battery disconnect	Battery disconnect	Power center
Starter (engine)	Generator starter motor	All receptacles
Head lights	All interior lights	Refrigerator
Taillights	Porch light	Air conditioner(s)
Stop lights	Trunk lights	Microwave
Turn signals	Power steps	Washer/dryer
Parking lights	Leveling system	Coffee maker
Backup lights	Water pump	Television (front)
Clearance lights	Monitor panel	Ice Maker
License plate lamp	Range vent	Television Lift (Front)
Dash lights	Power roof vent	
Map lights	Television (rear)	
Horn	Television antenna	
Windshield wipers	Water heater (electronic ignition)	
Electric windows	Furnace (electronic ignition)	
Backup monitor	Refrigerator controls	
Heater fans	VCP	
Defrost fans	Wall T-Stat	
Remote mirrors	CO Detector	
Radio	LP Leak Detector	
	Slide out/HWH	
	Jack Pump & Motor	

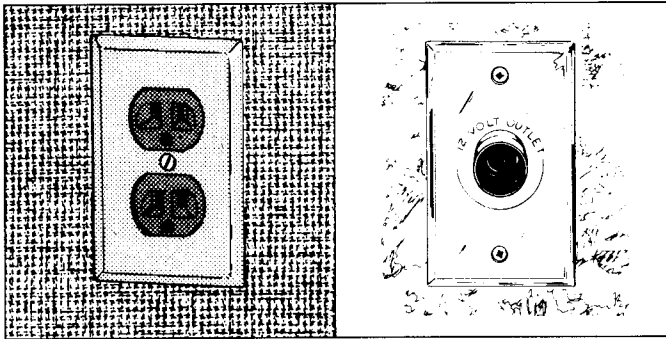

**120-VOLT AND 12-VOLT RECEPTACLES**

**120-VOLT SYSTEM**

The 120-volt system supplies power for the following through the power center: refrigerator, exterior receptacles, interior receptacles (used to operate regular household appliances), and optional roof air conditioner. The converter provides 12-volt power for all of the unit's 12-volt components. When the external 120-volt power cord is used, the power is connected directly into the main electrical service panel of the power center and is distributed through circuit breakers.

**GROUND FAULT INTERRUPTER/RECEPTACLE**

The bath, kitchen and exterior receptacles are protected by a ground fault interrupter (GFI). The GFI is a highly sensitive breaker, built into the bath and kitchen receptacles, and connected to the outside receptacle. It protects against severe electrical shock, if a ground fault occurs in that circuit. The GFI senses the fault and breaks the bath and exterior receptacle circuits. If this should happen, unplug all appliances on that circuit and reset the breaker in the bath or kitchen receptacle.

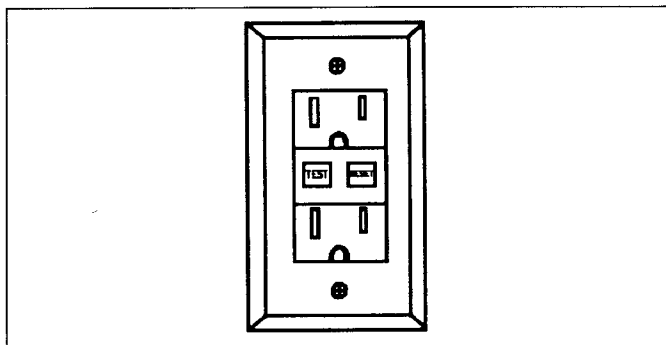

**GFI RECEPTACLE**

The GFI system should be tested at least once a month. To test the GFI system, plug a test light into the outlet and push the "Test" button on the receptacle. The test light should go out. To restore power, push the "Reset" button. If the button does NOT pop out or if the test light indicates a live circuit, DO NOT use the outlets. Contact your Coachmen dealer.

**SHORELINE CONNECTION**

The shoreline is a heavy-duty cable with a 3-prong grounding plug on one end, permanently attached at the other end, and connected to the power converter. It can be pulled from its storage compartment through a hatch in the

sidewall or through a porthole in a trunk of your vehicle and connected to a matching receptacle.

The 120-volt system is protected by the circuit breakers. If a circuit breaker opens, unplug the appliance(s) on that circuit, allow a short period for the breaker to cool, and rest the breaker. If the breaker continues to open, it may be caused by an appliance you have added, or a fault in the electrical system. If you determine it may be a fault in the electrical system, contact your Coachmen dealer.

**50 AMP SHORELINE SERVICE**

Your unit may be equipped with a 50 AMP service. You will then have a 4-prong plug. This will allow you to operate both roof airconditioners and any other appliances off of the shore line. There will be no selector switches with this option



*If you adapt the 50 AMP plug down to a 30 AMP, you will not be able to run both roof air conditioners at the same time. You may not be able to operate a washer/drier at the same time as a roof air conditioner.*

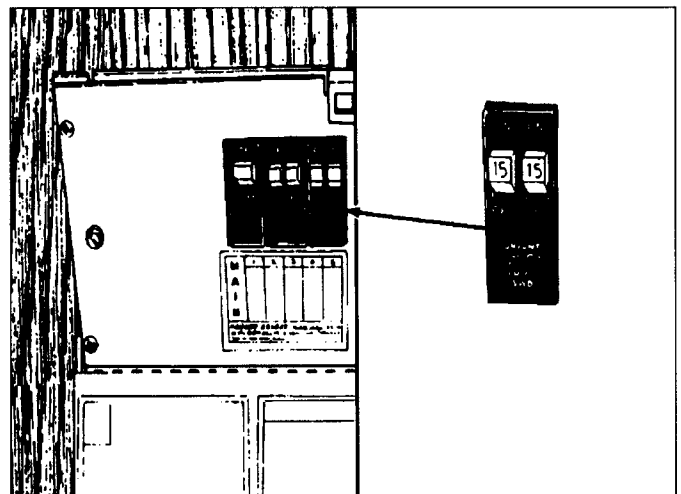

**CIRCUIT BREAKERS**

**GENERATOR**

The optional auxiliary generator is a gasoline-operated component that will supply 120-volt electricity. It can be operated when your vehicle is stopped or while you are traveling. It draws its fuel from the gasoline tank. The fuel pickup tube is designed so that it can not drain all of the gasoline from the tank. A labeled remote generator starter switch is provided inside your unit. There is also a START/STOP switch mounted on the generator. An automatic transfer switch incorporated in the power center prevents the simultaneous use of the generator and the shoreline connection.

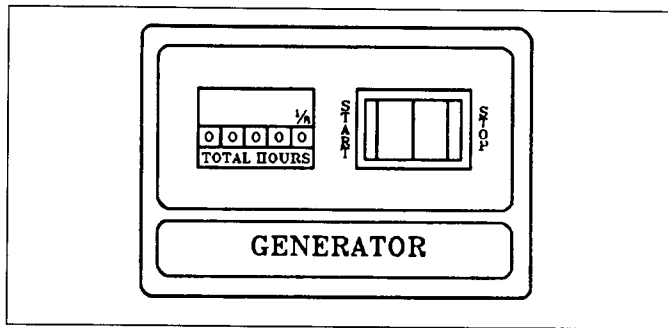

**REMOTE GENERATOR STARTER SWITCH**

When the generator is started, the transfer automatically switches from shoreline to generator power. When the generator is shut down, the transfer automatically switches to shoreline power. Every time you start the generator, there is a 30 to 45 second delay.



*When running the generator it will discharge carbon monoxide gas, particularly dangerous because it is colorless and odorless. Do not open roof vents, windows or doors. These could draw fumes into your unit. Do not operate the generator where an object such as a tree, bush or building can deflect exhaust to the inside of your unit. Do not operate the generator where exhaust gas could accumulate and seep inside an occupied vehicle, tent or building.*

### OPERATING YOUR GENERATOR

Familiarize yourself with the generator owner's manual. Before starting your generator, make sure the air intake and exhaust outlets are free of obstruction. Check the oil level. Make sure all 120-volt components are in the "OFF" position. Depress the generator START/STOP switch to start until the generator is running (when released, the switch will return to the neutral position).

**Note:** *When using the generator for the first time, apply the electrical load gradually to break in the engine. Operate the generator at 1/2 load for 30 minutes, then at 3/4 load for an additional 30 minutes before applying a full electrical load. After starting engine leave it running for a few minutes; this will prevent flooding. The generator is warranted by its manufacturer.*

### SHUT DOWN

To shut down the generator, press the START/STOP switch to stop and hold it there until the generator stops running.

**Note:** *Your generator is equipped with a Winter/Summer Carburetor Pre-Heat Switch which must be in the Winter position when outside temperature is 50 degrees or less.*

### CARE OF GENERATOR

The complete operation and care procedures for your generator are in the generator manufacturer's manual.

### A/C SELECTOR SWITCHES

The A/C selector switch is provided on all models with a double (front and rear) roof air conditioner option. Each model is equipped with a 30 amp service which enables you to run one (1) air conditioner off the shore-line connection. The selector switch directs which air conditioner receives power.

**Note:** *If your RV is equipped with a 7.0 KW generator it is possible to operate both (front and rear) A/C's simultaneously. Allow 30 to 45 seconds for generator to transfer power.*

### SELECTOR SWITCH OPTIONS

Some of the Coachmen high-line models are equipped with several options on the selector switch, washer/dryer and air conditioner, for instance. In this case there is an additional rocker switch installed in the vicinity of the selector switch. These switches are labeled and should be easy to operate. Simply select which appliance you wish to operate and set all switches accordingly.

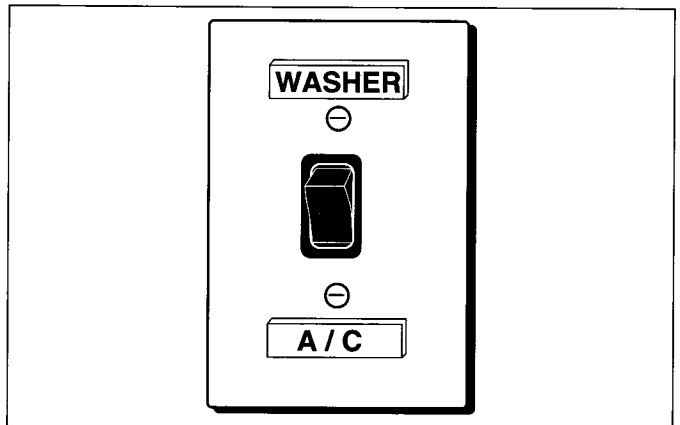

**SELECTOR SWITCH**

The washer/dryer package is offered in some Coachmen models. If your RV is equipped with a washer/dryer please refer to the washer/dryer manufacturer's operating instructions.

### 12-VOLT SYSTEM

The 12-volt system, which includes the automotive battery and RV battery (Figure 4, Page 54), plus the 12-volt converter, supplies power to the exterior lights, range hood fan and light, furnace blower, water pump, interior 12-volt receptacles, porch light and monitoring panel. The 12-volt receptacles can only be used for appliances specifically designed for that type of energy. The 12-volt energy is supplied by the automotive battery, the RV battery or the power converter.

The automotive alternator supplies 12-volt power to the vehicle's lights and components and to the RV's 12-volt system, including running lights, brakes and appliances, when the engine is running. The automotive alternator also will charge the RV battery(s). The RV battery supplies power to the furnace blower, monitoring panel, water pump, interior 12-volt receptacles, optional power vent(s), range hood fan and light and interior lights. The

RV battery is also charged by the power converter whenever you are using a shoreline connection, generator, external 120-volt power source, or the chassis engine.

To check the battery using the monitor panel, disconnect the shoreline and turn on at least three interior lights. (A discharged battery will show full charge unless some electricity is being drawn.) With extremely heavy usage, water level should be checked daily.

### CONVERTER

The power converter section of the power center transforms 120-volt AC into 12-volt DC to supply power to all of the 12-volt systems. Each 12-volt circuit is protected by a fuse in the power center. Turn the twist lock to open the door and check the fuses. A listing of the circuits is on the inside of the door. Some fuses protect circuits with more than one function; others may be for specific appliances.

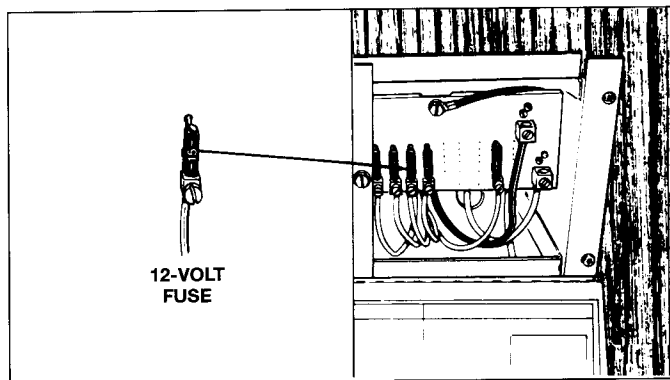

12-VOLT FUSE BLOCK

If a fuse is blown, turn off or unplug all appliances on that circuit. Replace the blown fuse with one of the same ampere rating. If the fuse continues to blow, notify your dealer. See the power center manufacturer's manual for specifications, operation and testing procedures.

### IN-LINE FUSES

In-Line fuses or over-current protective circuit breakers are installed in your RV storage battery hook-up whenever the battery supplies 12-volt current to the RV. The in-line fuses will be located within 18 inches of the battery (power supply) for easy access and working room.

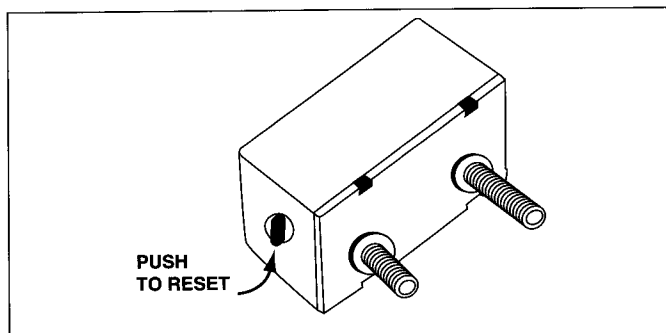

MANUAL RESET CIRCUIT BREAKER

**\* CAUTION \***

*DO NOT* replace a fuse with one of a higher AMP rating.

### FRESH WATER SYSTEM

Fresh water is supplied either by the vehicle's fresh water tank, using the 12-volt demand pump, or by an exterior pressurized source (city water).

The water heater is an LP gas appliance that heats water to a preset temperature. To fill the water heater, simply turn on a hot water faucet. When water flows steadily, turn the faucet off.

**\* CAUTION \***

*Do not* ignite the water heater until water heater tank is full. If it is not full, it will cause permanent damage to the water heater tank.

Although a common garden hose can be used to fill the water tank and connect to city water, longtime RVers recommend a hose specifically manufactured for this, available at your RV dealer. Keep a close watch while filling, so as to not overfill and cause damage to tank and surrounding structure.

To fill the fresh water tank, connect a hose to the city water fill. Place the valves in the tank fill position, then turn water on. When tank shows full on the monitor panel, turn water off. Place valves in normal operation position and remove hose. Turn water pump on, open hot water faucet until water flows. Turn hot water faucet off and repeat with cold water faucet. The water pump should shut off and not come on until a faucet is opened.

To use city water, connect a hose to the city water fill. Place the valves in the normal operation position. Turn water on, then open a hot water faucet until water flows. Turn faucet off and repeat with cold water. Water pump should be shut off for city water use.

**Note:** *In areas where city water pressure exceeds 60 PSI, you should use a pressure regulator. Excessive water pressure may damage lines, connections, or other system components.*

To add water to the tank where a city water hook-up is not available, use the following procedure;

After filling a water container, place the short piece of hose provided into the water (on some units, a plug may have to be removed and the hose installed in place of the plug). Place the valves in the TANK FILLED position, and open the valve in-line going to the hose, or open the suction fill valve. Turn water pump on. The pump will draw water from the container into the water tank. You may have to refill the container several times to completely fill the tank. After tank is full, turn valves back to normal operating position and close suction fill valve (or valve in line to short hose).

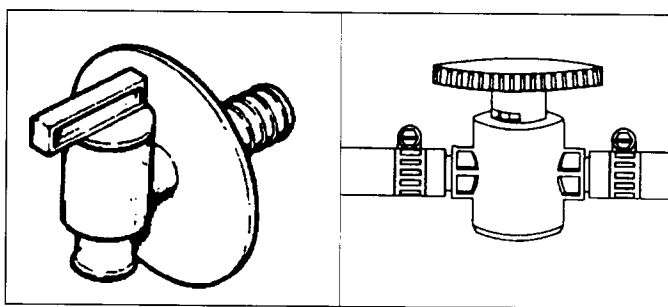
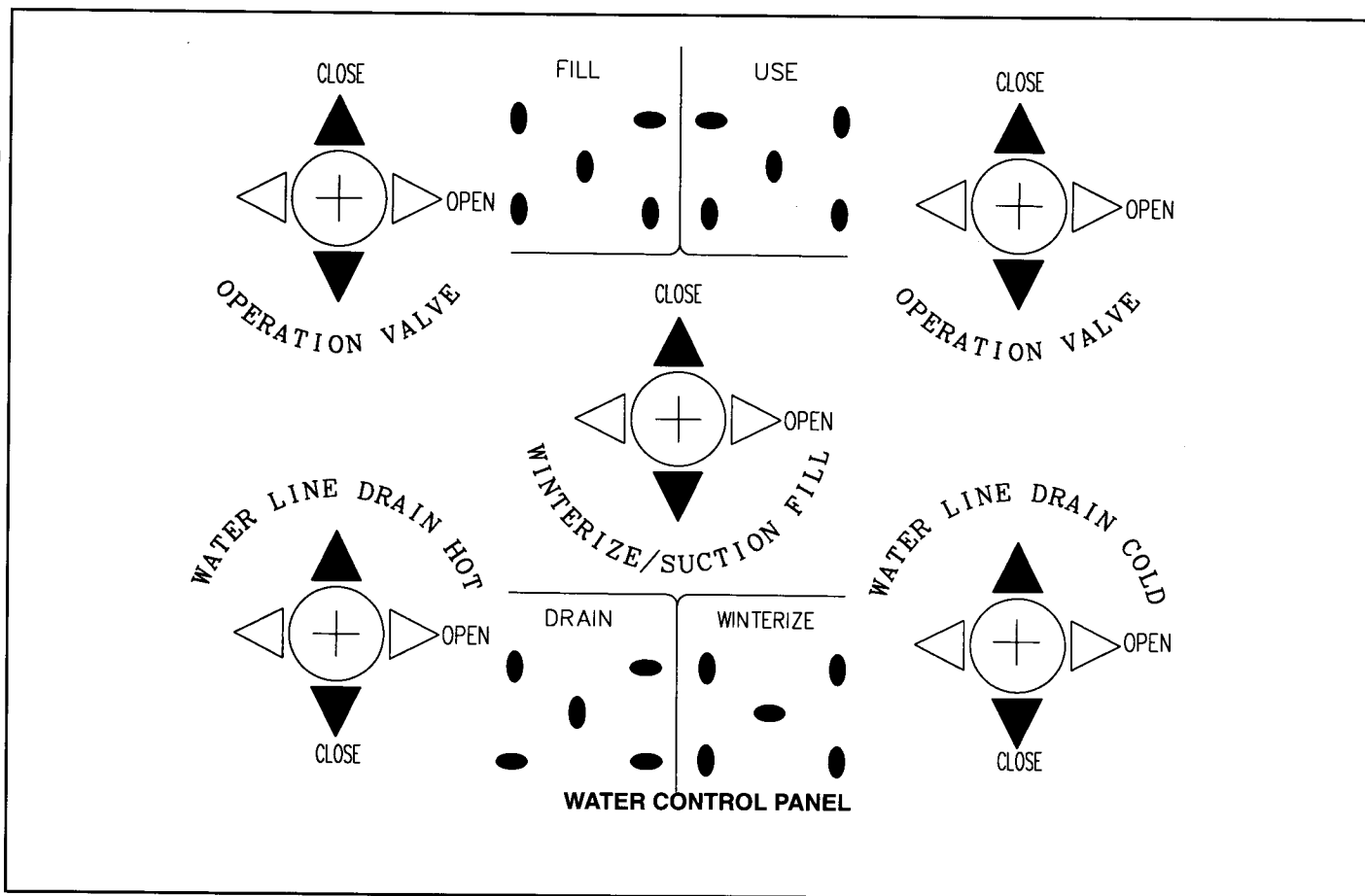

WATER TANK DRAINS

### WATER PUMP

The water pump is a 12-volt DC appliance that is activated by a switch on the monitor panel (on some models a second switch may be located in the bathroom). The switch can be left on while camping. When you want water, simply open a faucet. The pump which supplies water from the fresh water tank will run only as long as is needed. If the pump fails to start when the switch is on, check the fuse located in the power center. If the pump continues to operate whether the faucets are opened or closed, check the water tank. If the city water hose is connected, the pump will not run.

If the pump runs sporadically, the tank may be empty or there might be a leak in the system. If the city water is connected, the pump is not required. Be sure to turn the pump off when not in use. See additional information in the manufacturer's manual.

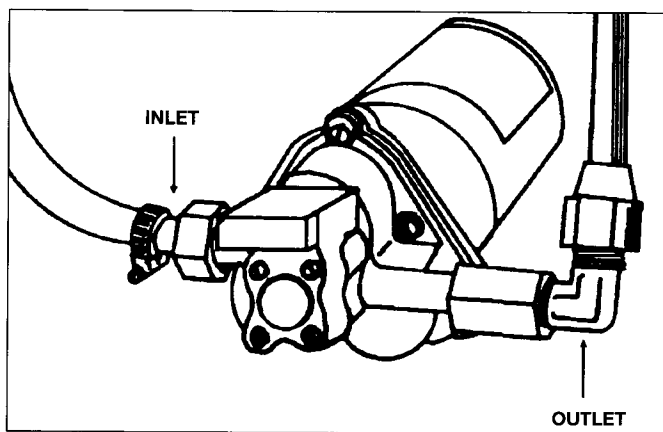

WATER PUMP

### WATER TANK

Because of a variance in weight distribution, the water tank may be beneath a sofa, dinette, bed or kitchen cabinet or under the floor of the unit.

The water tank should be sanitized before you use it for the first time, after a period of non-use, and whenever you suspect the tank is contaminated. To sanitize your water tank, first empty the tank and then use the following procedures:

1. Mix 2-1/2 cups of liquid household bleach with 10 gallons of water into a potable water container.

Place control valves in the tank fill position, and open the suction fill/winterize valve. Install the short length of hose in the winterization filling and place

free end of the hose in your potable water container. Running the water pump will drain water from the external container into the fresh water tank.

2. Turn the vehicle's water pump ON, open the hot water faucet, wait until the water begins to flow, and then turn the faucet off. Do the same with the cold water faucet. Wait three hours.
3. Open faucets and line drains. Drain the entire system. Some solution will remain in the water heater.

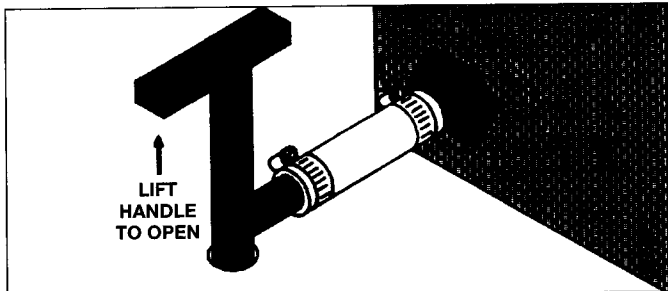

**LOW POINT DRAIN VALVE**

4. Connect a hose to the city water fill. Begin filling the tank, open the hot water faucet. Be sure the water pump is on. Let the water run until the system is completely flushed. Do the same with the cold water faucet. The hot water faucet will need to run longer to completely drain the water heater.

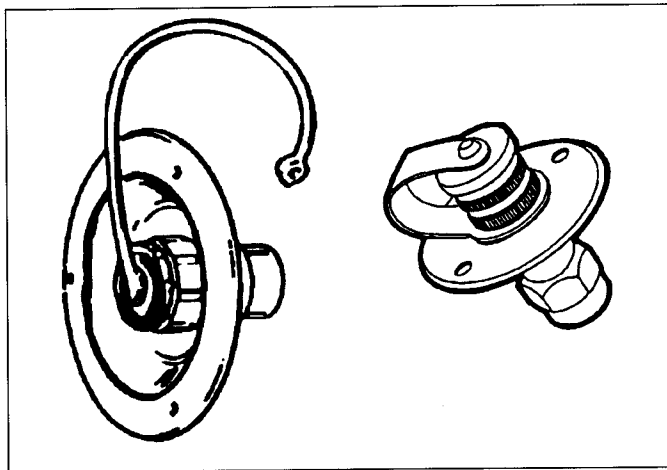

**CITY WATER FILLS**

5. If a chlorine taste lingers, flush the system with a vinegar and water solution (one quart of vinegar to five gallons of water). Wait two to three hours and then flush with fresh water.

### LEAKS

Traveling over bumpy or rough roads can cause pipe fittings to loosen. Check the pipe fittings in your unit regularly for signs of leakage.

### SHOWER

A shower hose anti-siphon device is installed on your faucet to prevent the possibility of backflow.

## DRAINAGE/SEWER SYSTEM

Your RV is equipped with a drainage sewer system that functions much the same as the one in your home. This system includes drain lines from the kitchen sinks, lavatory, tub/shower and marine type toilet to a gray-water holding tank and/or a sewage holding tank.

The drainage system also includes vents that carry odors (caused by drain water and waste) out through the roof. The drainage system vents also equalize the air pressure, which is necessary to maintain a water barrier against odors in the P-traps and to ensure smooth flow and escape for your drainage system.

### TOILET

Flush the toilet before initial use and after emptying the holding tank, this will help to prevent collection of solids. To help control odors, there are a number of toilet and holding tank treatment concentrates on the market. These chemical concentrates are available at your Coachmen dealer.

To operate the toilet, step on the small pedal to add water to the bowl. When you have the desired amount of water in the bowl, slowly release the pedal. To flush, step on the large pedal until the water swirls and then slowly release the pedal.

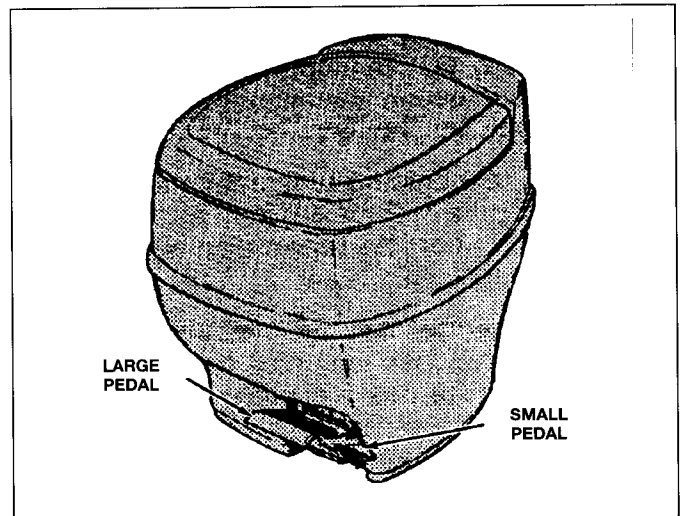

**TOILET**

When you clean your toilet, do not use highly concentrated or highly acidic household cleaners (no scouring powder). If the pedal does not move freely, apply silicone spray. To ensure proper operation and maintenance, refer to your toilet manufacturer's operating manual.

### HOLDING TANKS

Most unit drainage/sewer system have two holding tanks: gray water and waste (black) water. The gray water holding tank collects water from the kitchen sink, lavatory and tub/shower. The waste (black) water holding tank is used to collect waste from the toilet. In some units, one tank collects both gray water and sewage waste.



To prevent unnecessary accumulation of solids in the waste holding tank, do not put facial tissues or similar products into the toilet. It is highly recommended that you use only bio-degradable toilet tissue available from your RV dealer. Holding tanks should be emptied frequently into a specified dumping station. Most campgrounds have dumping stations, often at each campsite, and many service stations and highway rest areas have waste dumping stations also. Before emptying the holding tanks, make sure your vehicle is level; emptying the holding tanks depends on gravity.

To empty the holding tank, remove the sewage drain hose from its storage area. Remove the cap from the termination outlet and connect the sewage drain hose.

Some models have a swivel sewage drain hose holder under the unit. Simply swivel the holder around, take off the cap and hook up to a dump facility. Swivel the termination down, reach down in holder, pull up end of hose, remove termination cap and hook up sewer hose. Now you are ready to pull the gate valves and dump your tank.

Do not use harsh drain cleaner chemicals or solvents in the drains. Drain cleanouts are installed on certain units at intervals to facilitate drain line cleaning or unclogging. Use a wrench to remove and replace drain cleanout plug.

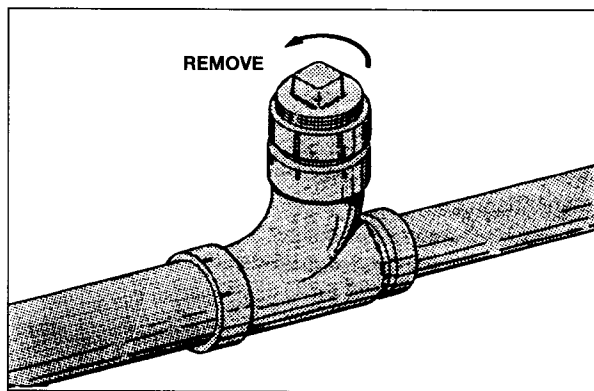

**DRAIN CLEANOUT**

While you are camped you may leave the gray water dump valve open only if the hose is connected and your campsite has a sewage hookup. Do not open the waste water dump valve until you want to empty the holding tank. If the waste water dump valve is left open, the rinse and flush water will run off and solids will be left to collect and harden in the bottom of the tank.

To drain a holding tank, pull out the dump valve slide handle. On some units it is necessary to unfasten a locking device before the slide valve handle can be pulled out. After the tank is drained, close the valve (if applicable, lock in place).

After emptying the waste holding tank, flush or pour about two gallons of water through the toilet and drain again. This flushes the tank and helps clean the drain hose. Repeat as necessary.

To empty the gray water holding tank, follow the same procedure used to empty the waste holding tank. A flushing may not be necessary. When the tank is

empty push the dump valve handle in until it seats (if applicable, lock in place). Remove the hose, wash it and return it to its storage holder. Replace the termination cap securely.

If your model is equipped with an outside shower this may be used to rinse out the inside of your sewer hose before leaving the dump facility.

It is recommended that you always drain the sewage waste holding tank first, and then the gray water tank. This assists in flushing and cleaning the termination valve and drain hose.

## LP GAS SYSTEM

The liquefied petroleum (LP) gas system in your unit furnishes fuel for hot water, heat, cooking and refrigeration (see illustration). LP gas provides a portable, efficient and inexpensive source of energy. It is stored in an LP gas tank which is mounted to the chassis of your unit and is serviced through an access door.

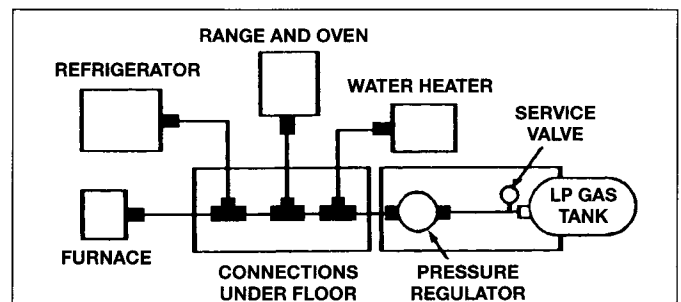

**LP GAS SYSTEM (TYPICAL)**

Under pressure in the tank, the LP gas turns to vapor; it is the latter that burns. Each tank has an automatic 80 percent stop-fill valve that allows space in the tank for vapor expansion. The high pressure of the vapor in the tank is reduced in two stages through a regulator (Figure 15, Page 55). The tank pressure will vary with temperature and altitude, but may be reduced to about 12 psi in the first stage, then to about 6-1/4 ounces in the second stage (the 6-1/4 ounces per square inch also is expressed as 11 inches of water column).

### **\* CAUTION \***

*LP gas is usually propane or a blend of propane and butane. When you fill your tanks, be sure to use propane ONLY. Do not use butane or butane mixtures.*

### **⚠ WARNING!**

*The LP gas system is designed and built to meet rigid standards, and it is tested before it leaves the factory. Your dealer also tests the system before it is delivered to you. **Except for simple maintenance and occasional tightening of a connection, always take your vehicle to an authorized dealer for LP gas problems. Always have an authorized LP gas supplier fill your LP gas tanks.***

**WARNING!**

LP gas burns readily and with intense heat. With proper care and maintenance, it is safe and efficient. There are, however, certain characteristics about LP gas you should know. **LP gas settles into any closed area, it displaces air and could cause suffocation if not detected. It also could create a fire or explosion hazard. In its natural state, LP gas is odorless. An additive gives it a distinctive mustard odor so that leaks can be readily detected. Under certain circumstances you may not be able to detect LP gas by smell. For that reason, your vehicle is equipped with an LP leak detector which will provide an audible warning if a propane leak is detected. Never disable or bypass this critical safety device.**

The following label has been placed in the vehicle near the range area:

**WARNING!**

If you smell or think you smell gas:

1. Extinguish any open flames, pilot lights, and all smoking materials.
2. Do not touch electrical switches.
3. Shut off the gas supply at the tank. **CLOSE valve(s) or gas supply connection.**
4. Open doors and other non-electrical ventilating openings.
5. Leave the area until the odor clears, and
6. Immediately call your gas supplier, and have the gas system checked and leakage source corrected before using again.

Before using any LP gas appliance, read the respective manufacturer's operating instruction manual.

**\* CAUTION \***

LP gas containers should not be placed or stored inside the living area of a vehicle. LP gas containers are equipped with safety devices that relieve excess pressure by discharging gas to the atmosphere.

**CLIMATE DIFFERENCES**

An appliance will not function if the LP gas does not vaporize. Propane continues to vaporize down to 44 degrees Fahrenheit below zero. Liquid gas does not vaporize as rapidly in cold weather, so you may place too great a demand on your tank's capacity in certain conditions. This can cause a refrigeration effect resulting in frosting of the tank and regulator. Check with your dealer or LP gas supplier about the appliance demands

that can be met by your tank at various temperatures. Always have your LP gas supplier add anhydrous methanol before filling the tank in cold weather.

Propane has become the main type of LP gas used in RVs. It is recommended that you use only propane gas. The names of LP suppliers can be found in the Yellow Pages of your telephone directory under "Gas-Liquefied Petroleum-Bottled and Bulk." Many campgrounds now have LP fill facilities, as do some service stations.

To operate any LP gas appliance, the LP gas SERVICE valve must be open. When first used, or after a refill, there may be some air in the gas lines that will escape when you first open a range burner or similar LP gas valve. The air may extinguish your match or igniter the first time or two before you get ignition. Remember too, that when you close the tank's SERVICE valve some of the gas will remain in the lines. To completely bleed the lines of gas, close the tank's SERVICE valve and light a range burner to use up the excess. When the flame burns out, turn the range burner off.

**REGULATOR PRESSURE**

Check the LP gas regulator at the beginning of each season or whenever a problem is indicated. Correct line pressure is 11 inches of water column. Your dealer or LP gas supplier can perform this check.

LP gas regulators must always be installed with the diaphragm vent facing down. Regulators that are not in compartments have been equipped with a protective cover. Make sure that the regulator vent faces down and that the cover is kept in place. This will minimize vent blockage that could result in excessive gas pressure and could cause a fire or explosion.

**LP LEAK DETECTOR**

It is recommended that your LP Leak Detector be in the ON position whenever you are using your RV. The system should be turned off when the vehicle is in storage or will be unused for several days.

If light does not come on, check in-line fuse behind the detector.

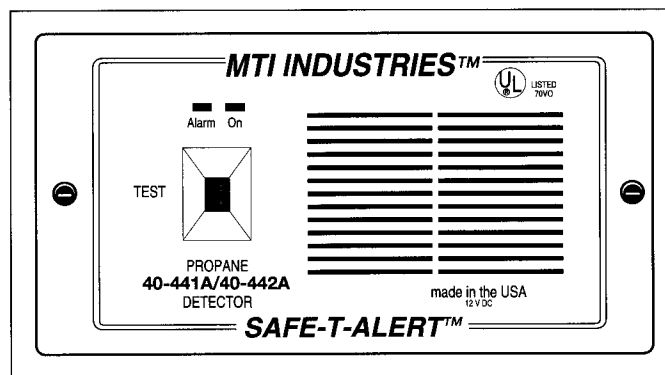

**LP GAS LEAK DETECTOR (TYPICAL)**

**LP GAS REGULATOR FREEZE-UPS**

LP gas regulator freeze-up is a problem RV owners can prevent if they are aware of its causes. Although

every precaution is taken by fuel producers, tank manufacturers, and LP gas dealers to keep moisture out of the fuel, this problem at times does exist and causes regular freeze-ups. Suggestions that you may want to follow to help prevent this moisture are:

1. Always keep the main tank valve closed during periods that gas is not in use, especially if the tank is empty.
2. Contact your LP gas dealer about the addition of anhydrous methanol to your tank. Your dealer may do this for a minimal charge, and it will help to prevent freeze-up.

### FILLING LP GAS TANKS

Before having an LP gas tank filled, be certain all burners and pilot lights are off.

Drive your motorhome to an authorized LP supplier for filling (never remove the tank). He will connect the fill nozzle to the LP gas tank fill valve. When the tank is being filled, the Service valve must be CLOSED and the 20% liquid level gauge must be OPEN. The 80% stop fill valve may close the valve before liquid appears at the 20% liquid level gauge, but if liquid does appear, stop filling immediately, the tank is filled to its liquid capacity. When liquid LP gas is no longer visible, close the liquid level gauge. Do not use a wrench to tighten the Service valve or the 20% gauge; they are designed to be closed leak-tight by hand. If you cannot hand tighten properly, the valve probably needs repair or replacement.

Because there may be some leakage of LP gas when the tank is being filled, we recommend that you drive at least a mile away from the LP gas dealer before you light any pilots or appliances if the scent of LP gas is present. Open the windows and doors and wait 30 minutes. If the odor is still present, follow the instructions in the LP LINE CHECK section, following the Warning.

### **WARNING!**

A warning label has been located near the LP gas container. This label reads:

**DO NOT FILL CONTAINER(S) TO MORE THAN 80% OF CAPACITY. Over-filling the LP gas container can result in an uncontrolled gas flow which can cause fire or explosion. A properly filled container will contain approximately 80% of its volume as liquid LP gas. If the tank is over-filled, have the LP gas dealer bleed out the excess. DO NOT smoke, strike a match, or ignite a lighter when the LP gas container is being filled. A spark or flame could ignite fumes. Be certain all burner and pilot flames are out and Service Valve is closed when filling your vehicle's LP gas or fuel tanks.**

### LP GAS LINE CHECK

Regular maintenance of the LP gas system is extremely important to insure the system's safety. All checks and/or repairs should be performed by an authorized service agency

who is trained in dealing with RV LP gas systems. DO NOT ATTEMPT repairs yourself. The system should be checked at least once every 30 days of use or 5,000 miles of travel. If you are using your vehicle in rough terrain situations or traveling over rough roads these inspections should be done more frequently.

If you check connections for leaks yourself DO NOT USE OPEN FLAME OR MATCHES TO CHECK LP GAS LINE CONNECTIONS. Use only an approved leak detector solution. DO NOT USE products that contain ammonia or chlorine (most common household soaps). If you detect a leak, shut off the gas and contact either your dealer or the nearest authorized LP gas dealer to have repairs made.

### **WARNING!**

**DO NOT MODIFY YOUR LP GAS SYSTEM. DO NOT REMOVE COMPONENTS OR REPLACE WITH COMPONENTS THAT ARE NOT OF EQUAL VALUE. Failure to follow this warning will void any vehicle warranty. Failure to follow this warning can result in explosion or fire which may cause injury or death.**

## APPLIANCES AND ACCESSORIES

### RANGE, RANGE HOOD, OVEN

Your motorhome has a three burner range and it may have an oven beneath the range. It has a power range hood with fan and light. The range burners and oven are LP gas appliances. Read the range manufacturer's manual carefully for complete details on the operation and care of the range, range hood and oven.

### **WARNING!**

**IT IS NOT SAFE TO USE COOKING APPLIANCES FOR COMFORT HEATING. Cooking appliances need fresh air for safe operation. Before operation:**

1. Open overhead vent or turn on exhaust fan.
2. Open window.

This warning is to remind you to provide an adequate supply of fresh air for combustion. Unlike homes, the amount of oxygen supply is limited due to the size of the recreational vehicle. Proper ventilation when using the cooking appliance(s) will avoid dangers of asphyxiation. It is especially important that cooking appliances not be used for comfort heating as the danger of asphyxiation is greater when the appliance is used for long periods of time.

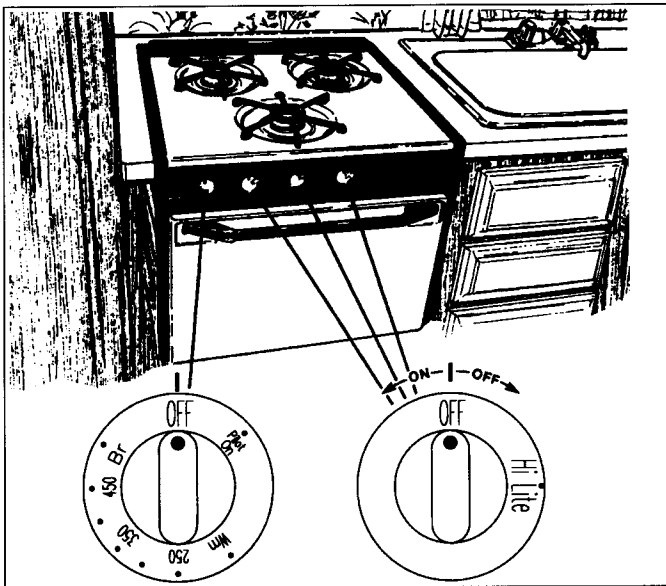

**RANGE AND OVEN CONTROLS**

### LIGHTING THE PILOTS

There are pilot burners on all LP gas ovens. All pilot lights are turned on and off by the oven control knob.

**\* CAUTION \***

*Be sure that appropriate knobs are turned off when burners are not in use to avoid the risk of unburned LP gas accumulating in the vehicle. The oven control knob must be in the PILOT'S ON position for the pilot(s) to be lit. Once lighted, the Pilot(s) will continue to burn.*

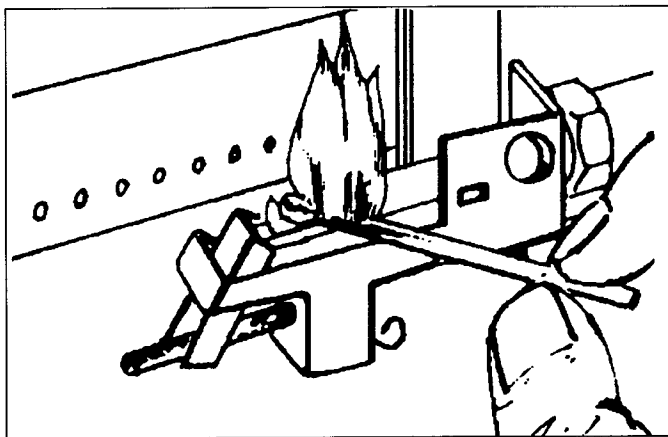

**LIGHTING OVEN PILOT**  
(when pilot is located on the right side of burner.)

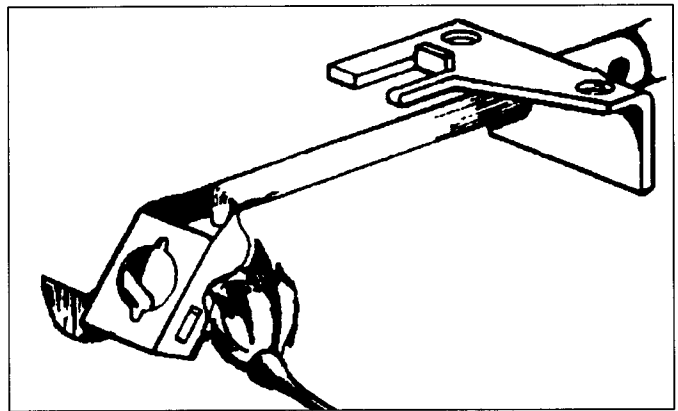

**LIGHTING OVEN PILOT**  
(when pilot is located on the left side of burner.)

### LIGHTING THE RANGE

Be certain that the LP gas Service valve is OPEN. Light a match and hold it close to the range burner making sure you are lighting the valve you turned on. Turn the burner's control knob to full ON. Air in the line may cause a blowing noise and may extinguish the match. When the line is free of air, the burner will light readily. Adjust the burner flame with the control knob.

### CARE OF RANGE AND OVEN

Allow the range top to cool, then clean it with hot, soapy water. Use a damp cloth to clean chrome surfaces. Grease splatters, which may bake onto the surfaces, should be wiped off before they have time to harden. Use chrome polish to remove stubborn stains.

Clean the oven with commercial cleaner after each trip, or as necessary. DO NOT apply cleaner to aluminum gas tubing, thermostat sensing bulb or electrical components.

### CARE OF RANGE HOOD

For metal surfaces, use the same procedure as for the range top. For the power hood, clean the plastic light cover by removing and washing it. If the light burns out, replace with a bulb of the same size. To clean the power hood filter, push slot located in center front of screen and pull down. If not greasy, simply tap the filter to shake out the dirt. If the filter is greasy, run hot, soapy water over it until grease dissolves. Allow the filter to drain and dry, then replace by positioning the flanges and push into place.

### MICROWAVE OVEN

The microwave oven is a 120-volt appliance used to cook, defrost or simmer foods in less time than other cooking methods. Several types of microwave ovens are installed by the manufacturer. Be certain to read carefully the oven manufacturer's owner's manual for specific instructions for the model which may be installed in your unit.

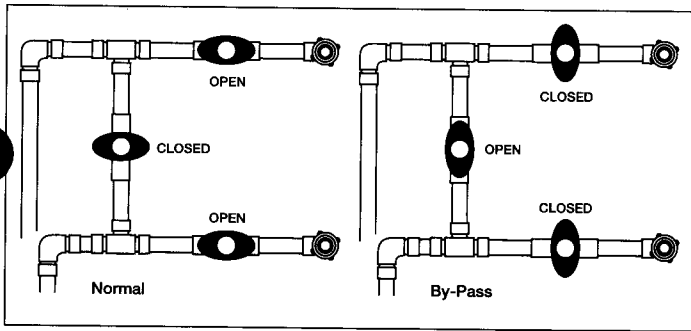

**WATER HEATER BY-PASS (TYPICAL)**

## WATER HEATER

Your water heater is an LP gas appliance capable of heating gallons of water to a preset temperature. When the system is connected to city water, fill the water heater by opening a hot water faucet. When filling the fresh water tank, turn the water pump ON and open a hot water faucet. In either case, when water flows steadily, turn the faucet OFF.

### WATER HEATER BY-PASS

There is a water heater by-pass system installed in the water lines at the back of the water heater. This by-pass system allows you to use the water system without the water heater, as well as winterize the water system without having to fill the water heater with anti-freeze. For normal operation, close the center valve and open the outside valves. To by-pass the water heater, open the center valve and close the outside valves.

### ELECTRONIC IGNITION

Place the remote water heater switch in the ON position. This switch is located in the lower right corner of the display panel. If the red fault light comes on, place the switch in OFF position and wait 5 minutes. The red fault light will only come on in the event of water heater malfunction or if the flame fails to light. After the required delay, again place switch in ON position. If the water heater turns on a green light will show on the display panel. It may take more than one start attempt when the water heater is being used for the first time or after the LP gas bottle has been refilled. To turn the water heater completely off place the switch in OFF position.

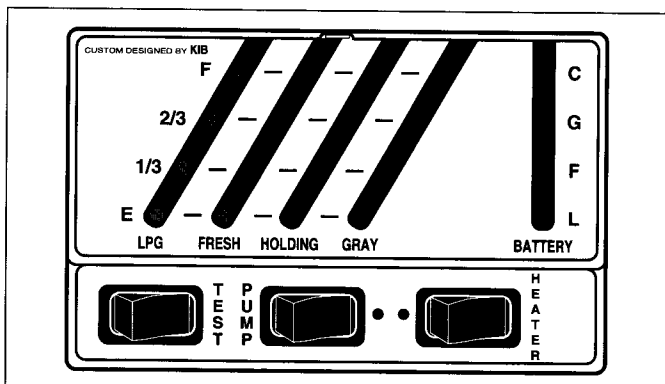

**REMOTE WATER HEATER SWITCH**

## BURNER ADJUSTMENT

Refer to Water Heater Operation Manual.

## DRAINING

The water heater has a drain plug or drain cock in the water heater which must be opened or removed to drain the water heater tank. To facilitate drainage, open all hot water faucets. When water ceases to drain, replace plug. Because of the location of the drain plug, about two quarts of water will remain in the bottom of the tank. This can be flushed as described in CARE OF WATER HEATER (listed following CAUTION).

### \* CAUTION \*

*Hydrogen gas can be produced in a hot water system served by a heater that has not been used for a long period of time (generally two weeks or more). HYDROGEN GAS IS EXTREMELY FLAMMABLE. To reduce the risk of injury under these conditions, it is recommended that the hot water faucet be opened for several minutes at the kitchen sink before using any electrical appliance. If hydrogen is present, there should be an unusual sound such as air escaping through the pipe as the water begins to flow. There should be no smoking or open flame near the faucet at the time it is open. Contact your dealer or the Coachmen Service Department at the address on the manufacturer's warranty if you are not certain of what action you should take.*

## CARE OF WATER HEATER

Be certain the exterior compartment is clean and does not contain combustible materials. Never obstruct the relief valve or exhaust vent. Periodically drain and flush the water heater tank.

To flush the tank, connect a hose to the city water fill. Remove the drain plug from the water heater tank. Run water for several minutes to flush tank. Turn water off and reinstall drain plug.

## FURNACE

The furnace is an automatic ignition type, controlled by a wall thermostat. Heat is delivered through a duct system.

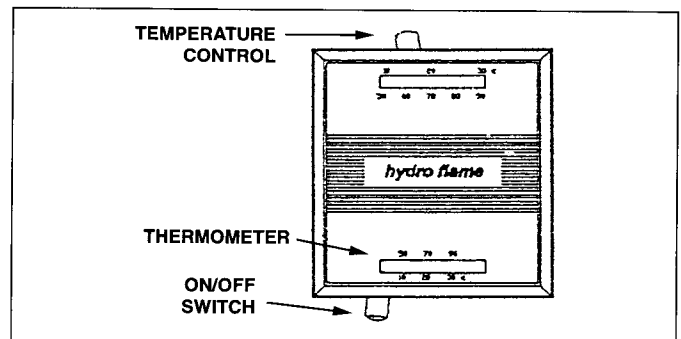

**THERMOSTAT**

**Note:** Although the furnace's fuel source is LP gas, the power operates on 12-volt electricity. The furnace requires a minimum of 9 volts to operate.

**\* CAUTION \***

*DO NOT use portable fuel-burning heating appliances, including kerosene heaters, wood and charcoal grills or stoves, in your motorhome. Such appliances produce excessive moisture, consume oxygen and may emit dangerous products of combustion.*

#### IGNITION

Before lighting a furnace, be sure the LP gas bottle Service valve is OPEN and the thermostat ON/OFF switch is ON.

#### AUTOMATIC MODELS

Set thermostat to desired temperature and turn ON/OFF switch to ON. An automatic relay in your furnace provides a time delay. Therefore, when you turn up the thermostat there will be a pause prior to startup of the blower. At blower startup, your furnace air will enter your living quarters at room temperature.

Your furnace will start warming quickly and continue getting warmer for the next several minutes. If your motorhome is cold throughout, it may take from one to several hours to heat all interior walls, ceilings, floors and fixtures to a comfortable temperature. Once reached, your furnace will automatically maintain steady warmth.

On initial lighting, the burner may not ignite due to air in the gas lines. If this occurs, set the thermostat back to the lowest setting and wait 30 seconds; then reset thermostat to the desired temperature.

**\* CAUTION \***

*If the furnace does not light after several attempts, while allowing each time for any delay pause, turn the thermostat OFF and contact your authorized Coachmen dealer or service center. DO NOT attempt to repair or adjust the furnace yourself.*

*When changing your unit's electrical source, as from 12-volt to shoreline or generator, turn the thermostat off. This will preserve the life of your furnace's electronic system. Carefully read the furnace manufacturers manual for other important Do's and Dont's of service and operation.*

#### PREVENTIVE MAINTENANCE

Preventative maintenance should be performed annually by an authorized dealer and should include cleaning of heat exchanger, furnace ducts and blower wheels to remove dust, lint and other foreign materials. the furnace's LP gas system should also be checked. Check manufacturer's manual for further information.

## REFRIGERATOR

Your refrigerator is two-way (LP gas and 120-volt electricity). It is equipped with a control system, which can automatically select the most suitable energy source which is available, either 120-volt AC, or LP gas operation. The refrigerator can be run either in a factory preset temperature setting AUTO mode, or in MANUAL mode.

The refrigerator controls will work down to 9.6-volt DC.

#### WARNING

**Most LP gas appliances used in recreational vehicles are vented to the outside of the vehicle. When parked close to a gasoline pump, it is possible that the gasoline fumes could enter this type of appliance and ignite from the burner flame, CAUSING A FIRE OR AN EXPLOSION.**

**FOR YOUR SAFETY, it is recommended that all LP gas appliances which are vented to the outside should be shut off when refueling.**

It comes with operational instructions and most have instructions posted near the controls. Ask your Coachmen dealer to demonstrate the operation of the refrigerator in your RV. The instructions given here are for your convenience; in case of a difference, use the instructions furnished with your refrigerator.

The refrigerator operates on the gravity flow of chemicals, so it must be level. If you must stop on an uneven site for more than 30 minutes, turn the refrigerator OFF. Use a level in the freezer compartment to check levelness.

Before starting on a trip, use the shoreline connection to cool the refrigerator the night before departing. Keep items to be stored in the RV refrigerator in your home refrigerator or freezer until you are ready to leave. This will reduce the cooling load on your refrigerator and help keep perishable foods fresh longer;. Always store food in sealable containers or suitable wrapping. When traveling, switch to LP gas operation. Use door lock during travel.

**\* CAUTION \***

*Some states and municipalities do not allow operation of LP gas systems while the vehicle is in motion. If you have a question in this regard, check with local law enforcement authorities.*

#### START UP INSTRUCTIONS

- A. A continuous 12-volt DC supply must be available for the electronic control to function.
- B. Press the main power ON/OFF button to the DOWN position.
- C. In AUTO mode operation, the temperature is automatically controlled by a factory preset temperature setting, on the energy source selected by the control system.

D. In MANUAL mode operation, the refrigerator will run continuously on the energy source selected by the control system.

**NOTE:** Under certain cool weather conditions the food in the lower portion of the fresh food compartment may freeze if operated for extended period of time on this mode.

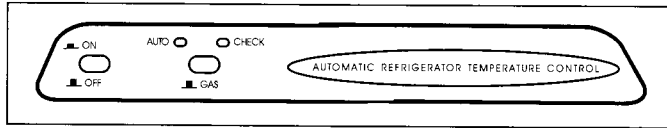

**REFRIGERATOR CONTROL PANEL**

### AUTO MODE

1. Press the AUTO/MANUAL mode selector button to the DOWN position. The AUTO mode indicator lamp will illuminate. If 120-volts AC is available, the control system will select AC operation. If 120-volts AC is not available, the control system will automatically switch to GAS operation. Within 45 seconds the burner should be ignited and operating normally.
2. If the CHECK indicator lamp illuminates, the control has failed to ignite the burner on GAS. To reset when the CHECK indicator lamp is illuminated, press the main power ON/OFF button to the OFF then ON position.
3. On the initial refrigerator start-up on gas (120-volts AC is not available), it may take longer than 45 seconds to allow air to be purged from the gas line. If the refrigerator has not been used for a long time or the LP tanks have just been refilled, air may be trapped in the supply lines. To purge the air from the lines may require resetting the main power ON/OFF button three or four times. If repeated attempts fail to start the LP gas operation, check to make sure that the LP gas supply tanks are not empty and all manual shutoff valves in the lines are open. If the problem is still not corrected, contact a service center for assistance.

**NOTE:** Do not continue to reset GAS operation if the CHECK indicator lamp continues to be illuminated after several tries.

4. In AUTO mode operation, the temperature is automatically controlled by the factory preset temperature setting.

### MANUAL MODE

1. Move the AUTO/MANUAL mode selector button to the UP position. The AUTO mode indicator lamp will go off.

The difference from AUTO mode is that in MANUAL mode operation, the refrigerator will run continuously on the energy source selected by the control system.

### TO SHUT OFF THE REFRIGERATOR

The refrigerator may be shut off while in any mode of operation by pressing the main power ON/OFF button to the UP (OFF) position. This shuts off all DC power to the control system.

**NOTE:** To avoid running out of battery the climate control should be turned OFF.

The interior light should be turned off during defrosting and storage periods, use a tape to close the light switch or remove the lamp bulb.

### CARE OF REFRIGERATOR

Remove food and ice after each trip. Clean the interior of the refrigerator with a lukewarm, mild baking soda solution. The evaporator, ice trays and shelves must, however, be cleaned with warm water only. Wipe dry with a soft, dry cloth. Never use strong chemicals or abrasives to clean the refrigerator; they can do harm to the plastic and aluminum surfaces. If the refrigerator is not in use for a period of time, turn all power OFF, empty and clean the interior and leave the door slightly ajar.

To defrost refrigerator freezer, remove food and ice. Turn the thermostat OFF. To speed up the defrosting process, fill the ice trays with hot water. When all frost is melted, empty the drip tray and dry the interior of the refrigerator with a clean cloth. Replace the drip tray and ice trays, replace all food stuffs and set the thermostat at MAX for a few hours. Later, reset the thermostat knob to its normal position.

### OPTIONAL REFRIGERATOR w/ICE MAKER

Your RV may have an optional refrigerator with a built-in automatic ice maker. Please refer to manufacturer's owner's manual for care and operating instructions.

### ROOF AIR CONDITIONERS

If you did not order the optional roof air conditioner at the time of purchase, your motorhome is wired so that one (or two) can be installed later. The roof air conditioner will operate only on 120-volt electricity.

More than one type of roof air conditioner is installed at the factory. Consult your Coachmen dealer and your roof air conditioner manufacturer's manual for specific instructions for the one installed in your motorhome.

Before starting any model of roof air conditioner, close all doors and windows. The controls for the air conditioner are on a panel on the portion of the appliance that is attached to the ceiling inside your unit. You can select cooling, fan only, or—with the optional heat package—heating. For information on electrical load refer to A/C Selector Switch section of this manual.

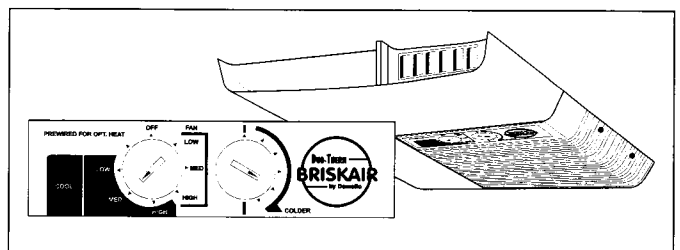

**ROOF AIR CONDITIONER—TYPICAL**

## AIR CIRCULATING ONLY/COOLING

Turn the Selector switch to COOLING, then rotate the thermostat to the position that is most comfortable to you and adjust the directional louvers to the desired direction of air flow. The compressor will cycle on and off, automatically maintaining the temperature you've set.

The optional heat unit on some models is not a substitute for a primary heating system. It is designed to warm the air during moderately cool days or nights. If your air conditioner is equipped with the optional heat package, turn the selector switch to HEAT and rotate the thermostat to the position most comfortable and adjust the directional louvers to the desired direction of air flow. The heater will cycle on and off automatically to maintain the temperature.

## DUCTED ROOF AIR CONDITIONING

The ducted roof air conditioning system is optional on some models. It utilizes ducts in the ceiling to distribute the air flow throughout your recreational vehicle. The air flow can be regulated by opening and/or closing the outlets of your choice. The thermostat for the ducted A/C system also controls the furnace. It is necessary to move the switch to the desired function, ie. heat or cool.

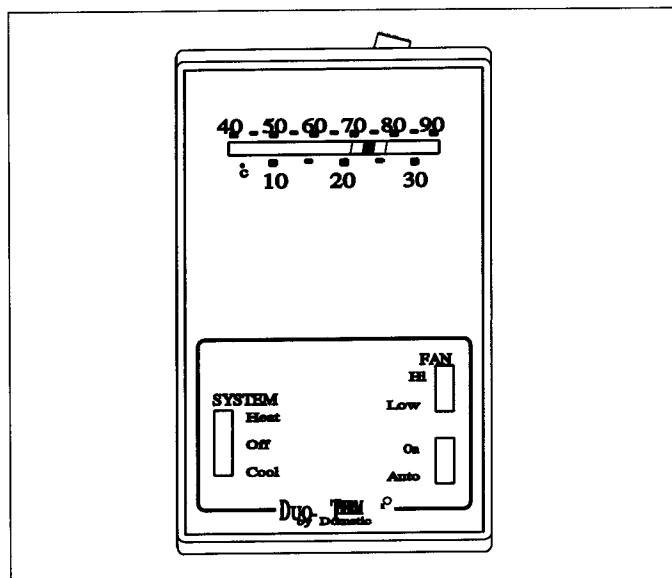

DUCTED A/C & HEAT THERMOSTAT

## WASHER/DRYER

The washer/dryer package is offered in some of Coachmen's highline models. If your RV is equipped with a washer/dryer, please refer to Selector Switch Options on page 23 for your power supply information and refer to the washer/dryer manufacturer's operating instructions.

## OPTIONAL LIVING AREA FEATURES

Your motorhome may be equipped with optional items you have chosen. For complete operating instructions for

those mentioned here and any others you may have selected, please refer to the manufacturer's owner's manual.

## AM/FM RADIO AND/OR CASSETTE TAPE PLAYER

For optimum performance, clean the tape head as often as necessary, depending on frequency of use. The tape head on most models can be cleaned with a special cleaning cassette cartridge; others can be cleaned with isopropyl alcohol on a cotton swab. Keep cassette tapes away from magnetized objects and follow manufacturer's recommendations for tape types and length. For specific operating instructions, cleaning, tuning and helpful hints, read your radio/tape player manufacturer's manual.

## TV ANTENNA/CABLE SYSTEM

This system allows you the flexibility to use the amplified TV antenna hook up, or cable, if your location has cable hook ups. To use the TV antenna, simply turn on the power supply switch at the wall plate. To use the cable, turn the power switch off at the wall plate.

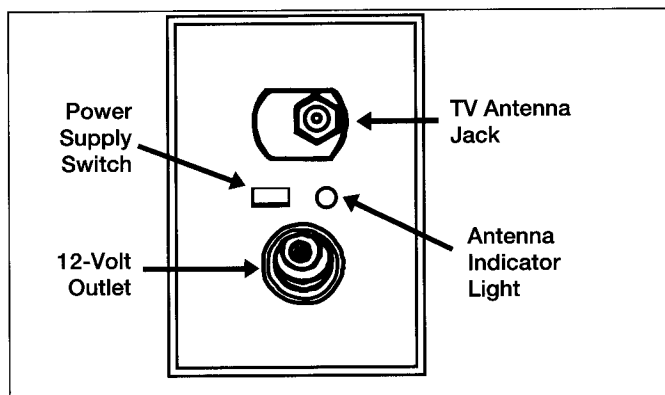

TV WALL PLATE

To raise the antenna, turn the antenna control handle in the up direction until some resistance is felt. Pull down the rotating knob to disengage it from the ceiling plate and turn it until you find the best sound and signal.

Always lower the antenna before moving your recreational vehicle. Pull down and turn the rotating portion so that the pointer lines up with the ceiling plate pointer. Turn control handle in down direction until some resistance is felt. Turn off the power switch on the wall plate.

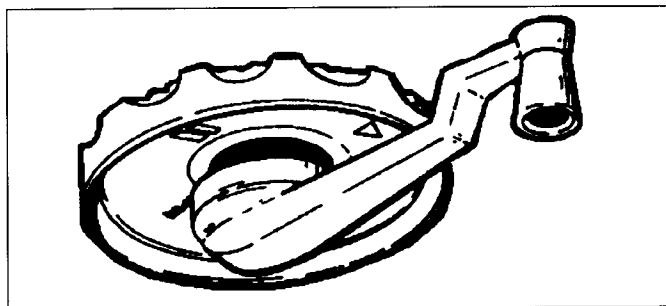

TV ANTENNA CONTROL

Most wall plates also have a 12-volt receptacle for TV sets designed to run on 12-volt DC power. This receptacle should not be used for high current devices



such as 12-volt hair dryers, as the maximum amp draw should not exceed 7.5 amps.

**Note:** Even though your 12-volt radio and/or TV antenna will operate on the 12-volt current that is supplied through the power converter, spikes and surges in the current are possible and will result in poor reception. It is recommended, therefore, that these items be used only in conjunction with a properly installed RV battery and the battery disconnect system in the "use" position

### TELEVISION

The optional color TV(s) installed in some models are placed in a convenient location designed to give you optimum usage. Refer to manufacturer's instructions for further information regarding tuning, care, etc.

### VCR/VCP

If your unit is equipped with a VCR or a VCP, please refer to the manufacturer's owner's manual for care and operating instructions.

### CABLE TV AND PHONE JACK

This enables you to receive cable TV. The phone jack is usually in the living area for convenience and accessibility. The outside portion of your phone jack needs only a direct feed line snapped into it for phone service to begin.

The cable TV package includes an outside receptacle to hook up your cable feed.

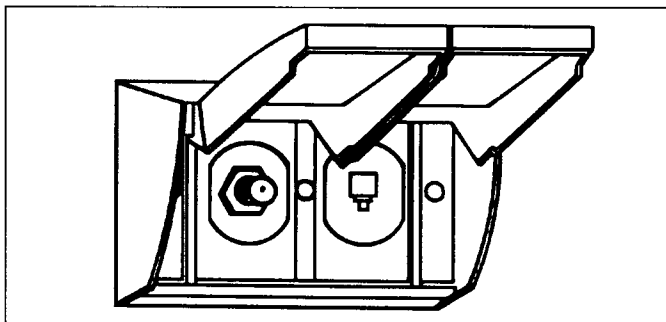

EXTERIOR CABLE TV & PHONE JACK

### BACK-UP CAMERA

This option has a camera mounted on the rear of your unit and a monitor on the dash allowing you to see to the rear while backing up. It can be turned on manually at the monitor. As a safety feature it also comes on automatically when you put your RV in reverse.

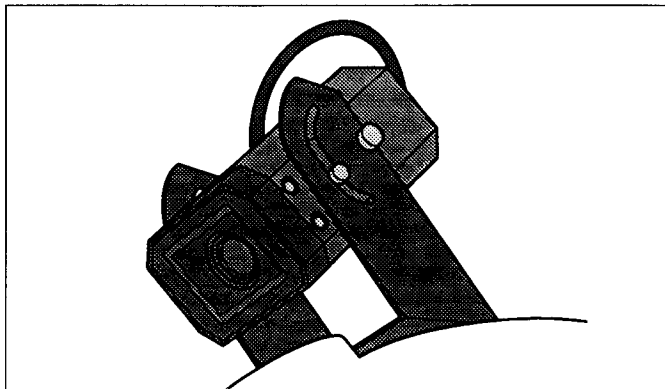

BACK-UP CAMERA

### BATTERY DISCONNECT

The Battery Disconnect can be utilized for either the coach or chassis battery. To operate the Battery Disconnect, press the USE/STORE switch to the USE position for either the coach or chassis. The indicator light for that battery will glow. To prevent the discharge of your batteries, press the USE/STORE switch to the STORE position. Additional loads may have to be removed from the batteries.

**Note:** Coach battery must be in the USE position in order for your coach battery to charge when plugged into the shoreline. All converters need the batteries connected to filter and stabilize the voltage output.

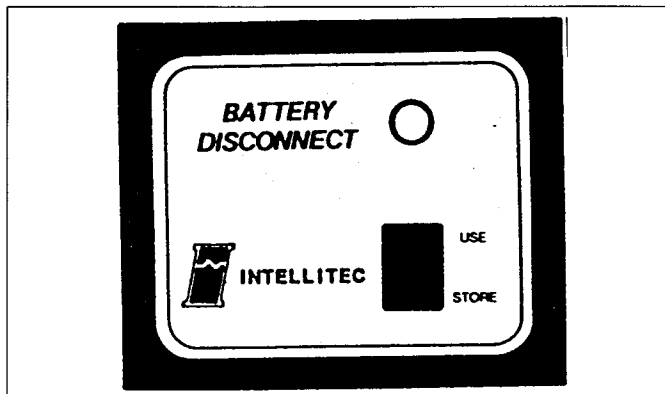

BATTERY DISCONNECT

### ELECTRIC STEP

Some models have the optional electric step (Figure 10, Page 55). Read the step manufacturer's manual for details on operation and maintenance.

With the entrance door open, flip wall switch ON. Close door and step should retract and lock in UP position. Open door, step should descend and lock in extended position with under-step light on.

Flip the wall switch to OFF and step should remain in down extended position, with under-step light off. When door is closed this will also retain step in the out position.

With wall switch OFF, step extended with the entrance door closed, turn on ignition switch; the special wall switch override circuit will go into action and your step which was mistakenly left down will retract automatically. If this occurs, when you next stop and turn the ignition off and

open the exit door, the step will remain in UP position until you flip the wall switch to ON. The step will then descend and lock in the extended position.

## MAINTENANCE AND LUBRICATION

Clean all mud, salt, and road grime from the step before lubricating. Lubricate all moving parts (bearings, pivot points, slides, clevis pin, and drive linkage ball) every 30 days with a good quality moisture and heat resistant penetrating grease.

**Note:** When ignition switch remains on, the step will always activate with entrance door movement regardless of where wall switch is set.

## STORAGE

You should follow these procedures if you will not be using your unit for an extended period.

### LP GAS

Close the LP gas container's Service valve. Extinguish all pilots and close all appliance LP gas valves (oven/range, water heater, refrigerator, furnace). Light a range burner to consume any gas remaining in the lines. When the flame burns out, turn the range burner off.

### WATER HEATER

Drain the water heater. To drain, see Water Heater Draining in the APPLIANCE section of this manual.

### WATER TANK

To drain see Water Tank Draining in the Fresh Water System of this manual.

### WATER PUMP

When the water tank and water lines have been drained, remove the outlet hose from the pump. Turn the pump on, allowing it to pump out any remaining water, usually about a cupful. Use a towel or cloth to catch this water. Reattach the outlet hose.

### ELECTRICAL SYSTEM

Turn off all circuit breakers at the Power Center. Disconnect all loads from the batteries. Make sure batteries are fully charged.

### GENERAL

Close and secure all doors and windows. Open a roof vent or window slightly to allow circulation, but not so far that rain or snow can enter.

### FUEL SYSTEM

During extended periods of vehicle storage (60 days or more) gasoline may deteriorate due to oxidation. This can damage rubber and other polymers in a unit's fuel system. It may also plug small orifices. To prevent such an occurrence, it is advised that a commercially available stabilizer ("STA-BIL" or equivalent) should be added to a vehicle's fuel tank whenever actual or expected storage periods exceed 60 days. The instructions for use accompanying the

product should be followed. The vehicle should than be operated at idle speed to circulate the additive throughout the fuel system.

## WINTERIZATION

Make special preparations for storing your unit in cold winter climates. All systems and components should be inspected and, if necessary, repaired prior to storage. Winterize the motorhome before removing the RV battery.

**Note:** If you will be using your motorhome during cold weather, be certain to keep the fresh water system drained or use an **approved, non-toxic** RV antifreeze to prevent freeze-ups. Have an LP gas supplier add methanol to your LP gas containers. Consult your authorized Coachmen dealer for more information.

### REFRIGERATOR

Remove all food from the refrigerator, defrost and wash and dry the inside. Prop the door open so air can circulate.

### CABINETS

Check the staple foods in your cupboards and remove any that could freeze and be damaged. Leave cabinet and closet doors open a little to prevent a musty odor or mildew.

### HOLDING TANKS

The dump valve shafts should be inspected and lubricated. Be certain the dump valves are closed.

### \* CAUTION \*

*Do not use automotive antifreeze in the water or sewage system. It is poisonous and also corrosive to sewage system components.*

### RV BATTERY

Recharge and add water, if necessary. Disconnect the battery cables and store battery in a cool, dry place. Check regularly and recharge as needed. Do not store battery in an area where possible exposure to extreme heat or sparks can occur. Be sure room is properly ventilated to dispel hydrogen fumes given off by battery.

### WINDOWS

Cover with newspaper or cardboard to protect fabrics from fading.

### EXTERIOR VENTS

Cover range hood, refrigerator and furnace vents with plastic. Inspect all roof vents and replace, if necessary.

### \* CAUTION \*

*Never use appliances with vent covers in place.*

## EXTERIOR

Clean and wax, lubricate locks and hinges. Check under the motorhome for any openings which would allow varmints to enter; seal if necessary. Lock securely. Inspect throughout the winter months and remove any snow accumulation from the roof with a long-handled broom or similar tool.

## WATER SYSTEM

To winterize the fresh water system, place the valves in the winterize position. Place the short section of hose in a container of RV anti-freeze. Open winterizer/suction fill valve. Turn on pump. The winter pump will drain anti-freeze from container into system. This will not put any anti-freeze into the water tank. Turn faucets until anti-freeze appears.

## FIRE SAFETY

Prevention is the best form of fire safety. Observe the same precautions in your RV as you do in your home.

Use care with any open flame inside of your unit. Follow the instructions previously listed for the care and maintenance, and operation of the various appliances in your motorhome.

Make certain everyone in your party is familiar with the emergency features of the unit, the location of exits and the location and operation of fire extinguishers. It is recommended that a fire drill be conducted on a regular basis to ensure this knowledge. A chemical fire extinguisher has been furnished with your unit. Check it regularly to be sure it is ready for emergency use. Immediately replace a fire extinguisher that is discharged or partially discharged. Fire extinguishers are located directly inside the front entrance door on either a cabinet or on the sidewall.

### \* CAUTION \*

*Do not bring or store LP gas containers, gasoline or other flammable liquids inside your RV.*

## SMOKE DETECTOR

Your motorhome has a smoke detector. Test it after the vehicle has been in storage, before each trip, and at least once a week during the time you actually use your motorhome.

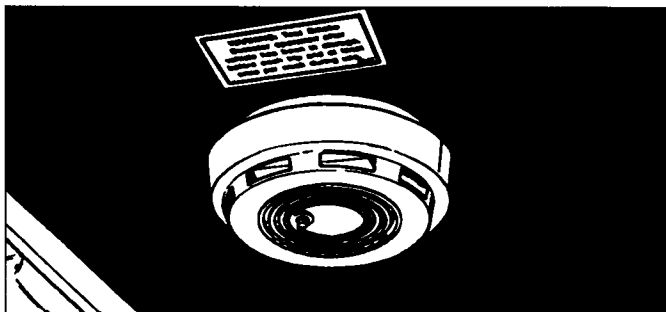

SMOKE DETECTOR

## EMERGENCY EXITS

Emergency exits are installed in some models. These will be marked by a label which has one-inch red letters. Handles that must be operated to open emergency exits also will be colored red. Make certain your dealer explains the location and operation of emergency exits to you, and that you inform all members of your party.

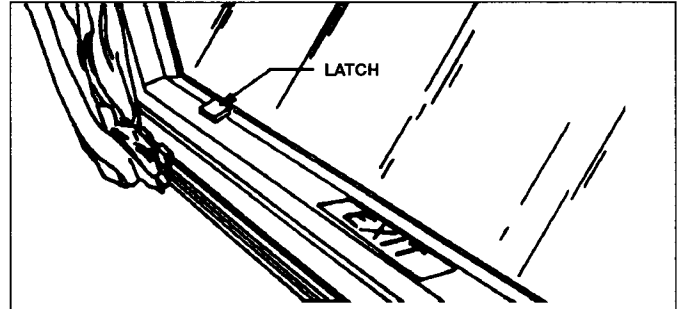

EMERGENCY EXIT WINDOW

## RV MAINTENANCE

RV owners are noted for the pride they take in the appearance of their units. Proper maintenance will do more than keep your motorhome looking nice. It can help ensure trouble-free operation and maximum efficiency of the appliances and accessories. Failure to maintain the vehicle or its components may also constitute a breach of your warranty obligations. Just as an open window or an unrepaired leak in your home may lead to costly damage, the failure to repair leaks in your vehicle or to reseal your seams may result in serious damage to your motorhome. Read the various appliance and component manufacturer's manuals for specific maintenance information.

Unless otherwise noted, maintenance functions should be performed at least annually. All maintenance schedules listed are the minimum requirement; heavy use, unusual temperatures or humidity, or other environmental conditions may require more frequent maintenance. At the start of each season, or after a period of storage, thoroughly inspect and test all systems and components to be certain they are functioning properly before you use your motorhome.

**Airing** of the unit is essential before you occupy it. See details under the AIR QUALITY and CONDENSATION sections of this manual.

**Automotive and Chassis System** of your vehicle should be serviced and maintained as outlined in the chassis owner's manual.

### \* CAUTION \*

*The interior engine access cover must be properly sealed to prevent engine exhaust from entering the living area of the vehicle. Make certain that carpeting or other materials do not interfere with the installation of the access cover.*

**Awning Supports** and bright metal parts should be cleaned and coated with silicone annually.

**Axle and Suspension** should be inspected frequently.

**Batteries** should be inspected frequently and refilled or recharged as necessary; battery cables and terminals should be checked and cleaned every 90 days.

**Body** should be washed to remove dirt, dust, road tar, bird and tree droppings, insects, and other foreign material from exterior surfaces. Use a mild soap in lukewarm water. Apply an automotive-type wax at least once a year.

**Bumper and Frames** that are painted, or any exposed painted surface, should be inspected for damage and rust. Rust should be removed and bumper and frame painted with rust preventive paint annually.

**Counter and Table Tops** should be cleaned periodically with a mild detergent.

**Cushions, Chairs, Sofas** may be labeled with the voluntary industry cleanability code. Because dyes or backings on some upholstery fabrics will be affected by water or solvents, the cleanability code will indicate the cleaning method that is safe for your fabric. If the furniture is not coded, test the fabric for discoloration on an inconspicuous part of the furniture before spot-cleaning. The code is symbolized by the following letters:

#### W

Use only water-based cleaning agents or foam. Mix two tablespoons ammonia or detergent, such as Ajax liquid, with a quart of water. Wipe the stain gently with a clean cloth dampened with the solution. Continue wiping, turning the cloth so that you are always using a clean portion, until the stain is removed. Be careful not to wet the fabric too much. Always wipe from the outer edge of the stain toward the center.

#### S

Use only mild, pure, water-free dry-cleaning solvents, such as Energine or Carbona. Dampen a clean cloth with the solvent and follow the same procedure described under W.

#### WS

Either of the above methods may be used.

#### X

Clean fabric only by vacuuming or light brushing to remove soil. Do not use liquid cleaning agents of any kind.

### TYPES OF STAINS

**Water-Based**—ketchup, soft drinks, milk, etc. Remove using method W.

**Oil-Based**—salad dressing, butter, greasy food, etc. Use method S or, for flat-woven fabrics, not velvet, apply Texize K2R Spot Remover according to directions.

**Combination**—ice cream, gravy, etc. are both watery and oily. Remove these types of stains using the S method and follow with the W method.

**Mud**—lift away what you can easily remove without forcing the mud into the fabric. Allow the remaining mud to dry completely, then vacuum. If the stain remains, clean with method W.

When overall cleaning is necessary, professional cleaners are recommended. However, if you wish to do it yourself, follow these suggestions:

1. Vacuum thoroughly.
2. Test fabric for discoloration on an inconspicuous place using a foam cleaner such as Fibre Fresh

Concentrate or Glamorene.

3. If no discoloration appears, use cleaner on entire item. *Note:* Many velvet fabrics cannot be cleaned with water-based cleaning agents.
4. After cleaning, you may wish to apply Scotch-guard fabric protector to such areas as furniture arms, backs and cushions.

*Note:* The above information is provided only as a service and should not be interpreted as a warranty. The list of cleaning agents does not constitute an endorsement of products; other similar products may be equally effective.

**Draperies, Curtains, Bedspreads** should be dry-cleaned only.

**Electrical System** should be inspected and tested prior to each rip. Check the shoreline for damage. Test the 120-volt system for proper polarity and voltage. You may want to purchase a ground monitor and a line voltage tester to perform these checks.

**Fabrics** need regular and continuing care. To keep them at their best, vacuum and brush away loose dirt before it becomes embedded and more difficult to remove. Clean spills and stains while fresh. VELVET fabrics should be cleaned with extreme care. Spills on velvet generally will bead-up. Blot them up quickly and gently so as not to force the stain deep into the fabric. If a stain remains, spot-clean using one of the methods described below. Wipe the stain in the direction of the pile to prevent distortion. When the fabric is dry, gently brush with a soft brush. Many velvet fabrics cannot be cleaned with water-based cleaning agents.

**Floor Coverings** should be cleaned as necessary. Vacuum carpeting. Avoid using heavy moisture; it could enter and damage your floor.

**Parquet Wood Flooring**—This optional flooring is located in the kitchen area. **Never damp mop** with water. It will permanently damage the floor. A slightly damp cloth is acceptable to use for spills in small areas. Please refer to owners' packet for maintenance and troubleshooting.

**Hinges** should be inspected and lubricated with light household oil periodically.

**Locks and Latches** should be inspected and lightly lubricated with graphite periodically.

**LP Gas** system should be inspected and adjusted as outlined in LP Gas section of this manual. Be certain mounting supports for tanks are secure. Before using, be sure all LP gas orifices and vents are clean.

**LP Gas Line Check** should be performed frequently. Always check the gas line connection after each refill and inspect the connections regularly, at least every 30 days or 5000 miles of travel. To check, turn off all burners and pilot lights. Open all doors and windows. Open the LP gas tank Service valve and use an approved LP leak detector solution to test all line connections. Bubbles indicate a leak. Do not use products that contain ammonia or chlorine. Tighten the connection with two open end wrenches until bubbles stop. If leak persists, contact your Coachmen dealer.

**Lug Nuts** should be checked every 50 miles for the first 200 miles or whenever a wheel has been reinstalled. If lug nuts continue to loosen, they should be replaced. Be certain to use the proper torque (85 to 95 ft.-lbs. standard wheels and 125 ft.-lbs. for

aluminum wheels). For more information check Chassis owner's manual.

**Roof, Body, Underbelly** should be inspected for damage, rust or corrosion every 90 days and repaired as necessary. You may wish to undercoat the frame components.

#### **Rubber Roof**

1. Keep your roof clean. Clean your roof four (4) times annually. For normal Cleaning:
  - Use a mild laundry detergent. (See caution below).
  - Rinse complete roof with clean water to remove any loose dirt or debris.
  - Using a medium bristle brush along with your selected cleaner mixed with water, scrub the entire roof. Rinse thoroughly with clean water to avoid residue build up on the roof or side wall of the vehicle.
  - For more difficult stains, you may use cleaning materials mentioned above in a more concentrated mixture. For stubborn stains, use of a rag dampened with mineral spirits is recommended. **DO NOT** use mineral spirits in a large area or allow it to soak into the membrane. Household bleach or windshield washer fluid can also be used (fully concentrated) and allowed to soak in stubborn stain areas, then scrubbed with a medium bristle brush or rag. Rinse thoroughly.

#### **\* CAUTION \***

*DO NOT use general purpose cleaners containing petroleum solvents, harsh abrasives, or citric based cleaners.*

2. Beware of areas where fruit or tree sap or harsh environmental fall out may stay on the roof for an extended period of time. These conditions may result in unremovable stains. If you are in these conditions, you may have to increase the frequency of your cleaning or premature deterioration may occur.

arms, backs and cushions.

If an accident happens and you damage the roof, here is a temporary fix: Clean the affected area with a rag dampened with mineral spirits and let dry. Cover the area by overlapping layers of duct tape over the troubled area, until a permanent repair can be made by your Coachmen dealer.

**Seams or Joints** should be sealed around the roof, entrance doors, windows, roof and wall vents, access doors, storage compartments, roof edges, luggage racks, ladders, air conditioners, TV antenna, rails and moldings at least once each year with a similar high-quality sealant. Inspect all seams and joints at least twice a year and reseal as necessary. Some sealants cannot be applied over other types; when preparing areas to be resealed, scrape off old sealant. Clean metal areas with a vinegar and warm water solution. Clean fiberglass areas with mineral spirits before applying new sealant.

**Shades, Blinds and Valances** should be vacuumed or wiped with a damp cloth.

**Sinks** in the RV kitchen and bathroom should be cleaned with a cleaner that is non-abrasive. Stainless steel and porcelain cleaner may be purchased at most

grocery stores. ABS cleaner may be purchased from your Coachmen dealer.

**Step(s)** should be inspected annually. Remove rust; paint steps and lubricate all moving parts.

**Tires** should be checked for damage and proper inflation prior to each trip. Bias-ply tires should be balanced and rotated annually; Radial tires should be balanced as necessary but, if required, these tires should be rotated front-to-rear or rear-to-front only.

**TV Antenna** exterior moving parts should be lubricated periodically.

**Vents** should be inspected and cleaned annually; lightly oil all moving parts. Inspect vents periodically for bird nests.

**Vinyl-Coated** ceiling and wall panels should be cleaned with a mild soap and damp sponge as needed.

**Water Heater** control compartment should be kept clean and free of combustible material and flammable liquids. The vent and combustible air grille should be clear of any obstructions. Manually operate the pressure temperature relief valve at least once a year. Operate only when storage water in tank is cool. Periodically compare main and pilot burner flame with illustrations in the manufacturer's operation instruction manual. Do not tamper with the pilot orifice to increase the pilot flame size; this can cause high water temperature and failure of gas control.

**Wheel Bearings** should be cleaned and repacked at least once a year.

**Windows, Doors, Compartment Doors** should be inspected for damage or leaks prior to each trip. Replace any damaged or worn parts. Fix or replace any leaking parts. Lubricate moving parts and rubber seals with silicone lubricant. Clean dirt and debris from window tracks.

**Wood Cabinetry** should be protected and cleaned several times a year using any good non-silicone wood polish. Careful control of temperature and humidity will help reduce expansion and shrinkage of doors and door panels. If shrinkage occurs and unfinished parts of the door panels are exposed, cover the exposed areas with matching touchup stain available from your Coachmen dealer

## GENERAL DRIVING CHECKS

For your safety, make certain that the following items have been checked and rechecked before you take your RV on the road. Make certain that all items inside of your RV are secured (e.g., lawn chairs, pots and pans, TV, etc.). As you travel, these items, if not secured, may become damaged or may damage the interior of your RV.

**Hydraulic Levelers**—Must be raised as far as possible. Visual check is recommended.

**Lights**—The following lights should be tested: brake lights, warning lights, flashers, clearance lights, taillights and headlights.

**Rearview Mirrors**—Adjust the rearview mirrors so that the driver can see the right and left sides of the unit.

## OTHER DRIVING CHECKS

Whether you are departing from your home, rest area or campsite, you should check the following parts of your unit before you take off.

**Tires**—Before each trip, check your tires for uneven wear, road damage, foreign objects or excessive peeling or bulging. Each morning, inspect the condition and pressure. Inflate the tire to the recommended pressure (indicated either on the tire or in the manufacturer's instruction booklet). Heat generated by surface friction will increase the tire's air pressure approximately six to nine psi; therefore, do not bleed air out of a hot tire.

**Note:** Proper tire inflation is extremely important.

A tire should be replaced when:

1. It is worn to 1/16-inch depth in two or more adjacent grooves.

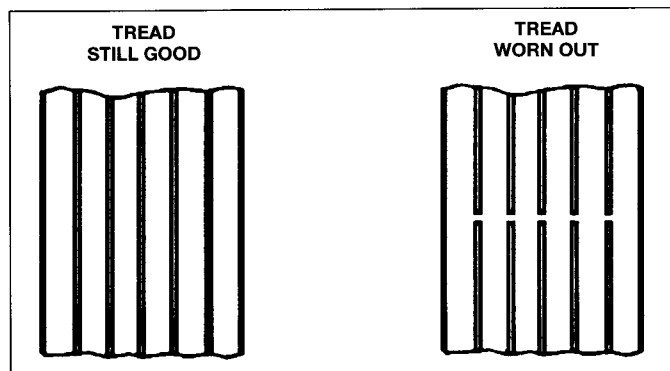

TREAD WEAR INDICATOR

2. It is worn to the level of the tread indicators that are molded into the bottom of the tread grooves, or
3. The indicators appear in two or more adjacent grooves at three locations around the tire.

On new tire purchases, be certain that the new tire is the same size as the old tire and that the new tire has the same ply rating and load range as the old one. DO NOT mix radial-ply tires with bias or bias-belted tires.

**Tire Change**—Change a tire on as level and firm a surface as possible. If you are on the roadside, activate the vehicle's warning flashers. Apply parking brake and move transmission selector to Park (P). Set up flares and/or warning lights. See the chassis manufacturer's owner's manual for specific jacking and tire removal and replacement instructions which pertain to your unit. Stop at the nearest service facility and have the torque checked.

**\* CAUTION \***

*Never place the jack under a bumper or edge of the sidewall. On units equipped with a tag axle, never place the jack under the tag axle. Use the jack only for changing tires. Never get underneath the vehicle when using the jack; always securely stow the spare tire in the proper area and return all jacking equipment to its proper storage area.*

**Wheel Lugs**—Wheel lugs must be tightened every 50 miles for the first 200 miles whenever a wheel has been reinstalled. Thereafter, check lugs after storage.

**Power Cord**—The 120-volt shoreline power cord must be unplugged from the external source and placed into its compartment. The cord hatch must be secured before you travel.

**Water Fill Hose(s)**—All hoses must be disconnected and all hose caps must be secured before you travel.

**Sewage Termination Valves**—These valves must be closed and locked before you travel. The sewer hose must be removed from the termination valve outlet and stored in the appropriate compartment. Termination caps must be securely fastened to the termination valve outlet(s).

**Door Step**—The door step (Figure 10, Page 55) must be returned to its travel position before the unit is safe for traveling. To do this, lift the front edge of the step and push it under the unit.

**Note:** Optional electric steps automatically retract.

**Windows and Vents**—All windows and vents should be closed completely or adjusted as desired before you travel.

**TV Antenna**—The TV antenna must be cranked down to its traveling position.

**Automotive System**—The automotive system of your vehicle should be serviced and maintained as outlined in the chassis owner's manual.

**Interior Doors and Drawers**—Close and secure all interior doors and drawers in your unit. Store or secure all loose items.

**Exterior Access Doors**—Exterior access doors for storage and equipment should be closed and locked.

# Appendix B ✓ Travel Preparation Checklist

## CLOTHING

Underwear  
Socks  
Shoes, sandals, boots  
Shirts  
Blouses  
Trousers  
Slacks  
Dresses  
Shorts  
Sweaters  
Jackets  
Coats  
Rainwear  
Swim wear  
Pajamas

## TOOL CHEST

Screwdrivers  
Pliers  
Hammers  
Tire pressure gauge  
Small level  
Electrical tape  
Masking tape  
Wrenches  
Allen wrench  
Furnace duct tape

## CAMPSITE COMFORT

Dishwashing soap  
Dishcloths  
Dishtowels  
Garbage/trash bags  
Mop  
Broom  
Vacuum cleaner  
Dust pan  
Paper towels  
Foil or plastic wrap  
Throw rug

## SAFETY

First-aid kit  
Flares  
Reflectors  
Tow rope and/or chain

## ADDITIONAL TOOLS

Hatchet  
Shovel  
Saw  
12-volt portable tire pump

## SLEEPING GEAR

Sheets  
Pillow cases  
Mattress pads  
Blankets  
Pillows  
Sleeping bags

## PERSONAL COMFORT

Towels  
Washcloths  
Toilet paper  
Soap  
Toothbrush  
Toothpaste  
Personal toiletries  
Scissors  
Sewing kit  
Ash trays

## MEAL PREPARATION

Bottle opener  
Can opener  
Matches  
Pots, pans, skillet  
Plates  
Glasses and cups  
Silverware  
Hot pads  
Knives, spatula, etc.  
Baking pans  
Coffee maker  
Toaster  
Plastic containers

## ENTERTAINMENT

Books/magazines  
Binoculars/telescope  
Camera, film, flash  
Tape player/tapes  
Toys/games  
Playing cards  
Television  
Radio

## MISC. EQUIPMENT

Bucket  
Fuses  
Fresh water hose  
Check type water hose fitting  
Flashlight  
20-ft. 3-prong power cord  
3-prong adapter with  
grounding wire  
Wheel chocks, leveling ramp,  
blocks or jack stands  
Coat hangers  
Folding lawn chairs

## Appendix C ✓ Troubleshooting Guide

*NOTE: Use the manufacturers' owner's manuals for all appliance trouble shooting.*

PROBLEM	CAUSE	SOLUTION
<b>ELECTRICAL POWER</b>		
No electrical power to unit.	Shoreline connection.	Make sure you have power to the shoreline.
	Circuit breaker (120V) may be off or tripped.	Reset breaker(s) at power center.
	Circuit breaker (12V) may be tripped.	Reset breaker at battery compartment.
<b>POWER CONVERTER</b>		
Converter makes a clicking noise.	Circuit overload.	Reduce load on circuit.
	Reversed polarity at battery.	Correct polarity at battery.
	Short in recharge line.	Locate and fix short.
<b>ELECTRICALLY CHARGED (HOT) CHASSIS</b>		
Chassis is electrically charged.	Short in 110/120 volt circuit.	Disconnect unit from electrical supply. Have unit inspected and repaired if necessary, by a qualified service facility.  <i>NOTE: Determine if shoreline has proper polarity.</i>
	Power cord ground wire removed.	Make sure shoreline post ground is earth ground and power cord ground is used.
<b>LIGHTS</b>		
Lights flickering.	Loose fuse holders.	Tighten or replace fuse holder.
	Blown fuse.	Replace fuse with one of the same ampere rating.
	Broken connection or wire.	Replace connection and/or wire.
	Bad ground.	Make sure ground connection is secure.
	Converter overheating.	Let converter cool down, reduce load.
Lights dim or half bright.	Bad battery.	Check battery condition.
	Possible converter malfunction.	Have converter checked by an authorized service center.
	Possible low voltage from shoreline.	Make sure voltage to shoreline is not too low.



*NOTE: Use the manufacturers' owner's manuals for all appliance trouble shooting.*

<b>PROBLEM</b>	<b>CAUSE</b>	<b>SOLUTION</b>
----------------	--------------	-----------------

**OUTSIDE RECEPTACLE**

No power to outside receptacle.	GFI breaker switch may be off or tripped.	Reset GFI at receptacle.
	Bad power source.	Make sure you have power to the shoreline.

**GENERATOR**

Generator cranks but will not start.	Generator may be out of gas.	Check the fuel.
	Generator may be low on oil.	Check the oil.
Generator starts but no power.	Fuse on the generator may have blown.	Replace fuse with one of the same ampere rating.
	Breaker switches may be off or tripped at generator.	Reset breaker.
	Circuit breaker may be off or tripped inside power center.	Reset main breaker.

**RV BATTERY**

RV battery boiling.	Water low in battery.	Refill water to correct level in battery.
	Bad battery.	Replace battery.
	Defective converter.	Have converter checked by an authorized service center.

**RUNNING LIGHTS**

No running lights.	Blown fuse.	Replace fuse with one of the same ampere rating.
	Bad bulbs.	Replace bulbs.
	Bad ground (rear only).	Check white ground wire at rear frame.





# Maintenance Schedule\*

ITEM							REFERENCE
	Every Trip	Every 30 days or 1,000 miles	Every 60 days	Every 90 days or 2,500 miles	Every 6 months or 5,000 miles	Annually or 10,000 miles	
Airing	•						Air Quality, Condensation, Maintenance, this manual
Appliances	•					•	Appliances, this manual; Appliance Manufacturer's instructions
Awning Supports						•	Maintenance, this manual
Automotive System	•						Chassis Manufacturer's manual
Auxiliary Heater (Rear)	•		•				Maintenance, this manual
Batteries	•	•					Maintenance, this manual;
Brakes & Suspension					•	•	Maintenance, this manual; Brake & Suspension Manufacturer's manual
Body					•		Maintenance, this manual
Bumpers						•	Maintenance, this manual
Counter, Table Tops	•						Maintenance, this manual
Doors				•			Maintenance, this manual
Electrical System	•						Maintenance, this manual
Fabrics						•	Care of Fabrics, this manual
Floor Coverings	•						Maintenance, this manual
Frame						•	Maintenance, this manual
Hinges						•	Maintenance, this manual
Locks & Latches						•	Maintenance, this manual; Lock/Latch Manufacturer's manual
LP Gas	•	•					LP Gas; this manual; Appliance Manufacturer's instructions
Lug Nuts	•						Maintenance, Chassis manual
Roof, Body, Underbelly				•			Maintenance, this manual
Seams (Seal)						•	Maintenance, this manual
Shades, Valances	•						Maintenance, this manual
Steps	•					•	Maintenance, this manual; Step Manufacturer's instructions
Tires	•					•	Pre-Travel Check, Maintenance, this manual; Tire Manufacturer's manual
TV Antenna		•					TV Antenna Manufacturer's instructions
Vents						•	Maintenance, this manual; Vent Manufacturer's instructions
Vinyl Ceiling & Wall Panels	•						Maintenance, this manual
Water Heater	•					•	Maintenance, this manual; Water Heater Manufacturer's manual
Windows	•						Maintenance, this manual; Window Manufacturer's instructions
Wood Cabinetry	•		•				Maintenance, this manual

\* Maintenance schedules listed are minimum requirements; heavy use, unusual temperatures or humidity, or other environmental conditions may require more frequent maintenance.

# Appliance Identification Form

Should your unit or one of the appliances require warranty service, you will have to identify the manufacturer, model designator and serial number. Fill in this form as soon as possible. It will help you meet identification requirement. Depending on your unit, certain items listed below may be offered as either optional and/or standard. Most of this information can be found on the Recreational Vehicle Data Card attached to the inside of one of the kitchen cabinets.

EQUIPMENT	MANUFACTURER	MODEL DESIGNATOR	SERIAL NUMBER
Automotive Air Conditioner	_____	_____	_____
Converter	_____	_____	_____
Electric Water Pump	_____	_____	_____
Furnace	_____	_____	_____
Generator	_____	_____	_____
VCR/VCP	_____	_____	_____
Keys—Door	_____	_____	_____
Exterior Storage	_____	_____	_____
Other	_____	_____	_____
Microwave Oven	_____	_____	_____
Motorhome Body	_____	_____	_____
Motorhome Chassis	_____	_____	_____
Radio/Cassette	_____	_____	_____
Range/Oven	_____	_____	_____
Refrigerator	_____	_____	_____
Washer	_____	_____	_____
Dryer	_____	_____	_____
Roof Air Conditioner(s)	_____	_____	_____
Toilet	_____	_____	_____
TV	_____	_____	_____
TV Antenna	_____	_____	_____
Water Heater	_____	_____	_____

## LIGHT BULBS—CLASS A

INTERIOR	Ceiling Light (Typical)	1141
	Wall/Overhead Lamp	1076
	Flourescent Light	Sylvania F8 w/w
	Aircraft Style Map Light	903
	Floor Courtesy Light	SE 194
	Refrigerator Light	Phillips 12866 10w
	Range Hood Light	912
	Bullet Reading Light	F1003
	Overhead 120 Volt (Double)	60w
	Overhead 120 Volt (Triple)	25w
EXTERIOR	Clearance Light	CE 194
	Compartment Light	GE 168
	Mirror Signal Light	CE 194
	Fog Light	Solite 894
	Docking Light	GE H7614 Flood
	Porch Light	93
TAIL LIGHTS	Mirada Stop/Turn	2057
	Mirada Back Up	1156
	Catalina & Santara Turn/Back Up	3156
	Catalina & Santara Stop	3457

## MISCELLANEOUS

See the brochure for the exterior dimensions, weight ratings, wheel/tire ratings and specifications.

## **Reporting Safety Defects**

**If you believe that your vehicle has a defect which could cause a crash or could cause injury or death, you should immediately inform the National Highway Traffic Safety Administration (NHTSA) in addition to notifying COACHMEN RECREATIONAL VEHICLE COMPANY.**

**If NHTSA receives similar complaints, it may open an investigation, and if it finds that a safety defect exists in a group of vehicles, it may order a recall and remedy campaign. However, NHTSA cannot become involved in individual problems between you, your dealer, or COACHMEN RECREATIONAL VEHICLE COMPANY.**

**To contact NHTSA, you may either call the Auto Safety Hotline toll-free at 1-800-424-9393 (or 366-0123 in Washington, D.C. area) or write to: NHTSA, U.S. Department of Transportation, Washington, D.C. 20590. You can also obtain other information about motor vehicle safety from the Hotline.**



Coachmen Industries, Inc. was founded in Middlebury, Indiana, in 1964 by Claude, Keith and Tom Corson. The three brothers recognized business opportunities in the new and growing recreational vehicle (RV) industry and tried to combine their business experience in finance, marketing and manufacturing.

Their confidence in the RV industry was well founded. From first-year production that included 12 travel trailers, one pick-up truck camper and 80 truck caps, the Company

has become a diversified, full-line manufacturer of recreational vehicles under many well-known brand names with well over 449,000 units manufactured. The Company's RV product line includes travel trailers, fifth wheel trailers, motorhomes, truck campers, camping trailers and van conversions.

The Coachmen RV complex includes 120 acres with 588,000 square feet of assembly facilities under roof.



RECREATIONAL VEHICLE CO.  
P.O. Box 1000  
Middlebury, Indiana 46540

The Coachmen recreational vehicles described in this manual incorporate components produced by Coachmen Industries, its divisions, and various other suppliers. During the product year, Coachmen may decide to produce units with different components and/or specifications than initially scheduled. All such changes are approved for use by Coachmen in order to maintain the quality standards associated with the Coachmen name. All illustrations and specifications contained in this owners manual are based on the latest product information at time of publication. Coachmen reserves the right to make changes in operations, materials, equipment and specifications at any time without notice. Coachmen assumes no responsibility for any error in type or print reproduction of specifications in this owners manual. Check with your Coachmen dealer for more information if you have specific questions.